



---

**F&F Filipowski sp. j.**  
**ul. Konstytucyjna 79/81, 95-200 Pabianice**  
**POLAND**

*The F&F company was established in 1992 based on a commercial and service company active in the electronic sector. The previous marketing and technical experience (mainly in terms of electronics and electrical engineering) enabled its owners to establish a manufacturing company offers a wide range of electronic appliances for both domestic and industrial applications. The work of F&F's Research and Development department in cooperation with the scientific society and customers leads to expand and offer and allows to create devices on higher technological advancement level, exemplified by the series of programmable controllers and PLC MAX intelligent home system F & Home.*

*Nowadays, the F&F brand has been widely known in Poland. The company delivers its products to customers in Russia, Ukraine, Belarus, Lithuania, Latvia, Slovakia, Romania, Czech Republic, Hungary, Germany, Portugal, Spain, France, Ireland, Sweden, Norway, Finland, Chile, and the United States.*

---

## **CONTACT**

tel/fax +48 42 215 23 83  
+48 42 227 09 71

<http://www.fif.com.pl>

e-mail:

office: [fif@fif.com.pl](mailto:fif@fif.com.pl)  
sales division: [handlowy@fif.com.pl](mailto:handlowy@fif.com.pl)  
technical division: [dztech@fif.com.pl](mailto:dztech@fif.com.pl)

**BIURO BADAWCZE ds. JAKOŚCI**  
STOWARZYSZENIA ELEKTRYKÓW POLSKICH  
JEDNOSTKA CERTYFIKUJĄCA WYROBY  
04-703 Warszawa, ul. Piłsudskiego 28  
tel. (+48 22) 812 53 35, fax (+48 22) 812 53 80  
e-mail: biuro@sep.com.pl

**CERTYFIKAT Nr B/12/452/04**  
aprobujący do oznaczenia wyrobów znakami bezpieczeństwa

Nazwa i adres posiadacza certyfikatu: **F & F FILPOWSKI Spółka Jawna**  
ul. Konstancyńska 79/81  
95-200 Pabianice

Nazwa i adres producenta: **F & F FILPOWSKI Spółka Jawna**  
ul. Konstancyńska 79/81  
95-200 Pabianice

Nazwa wyrobu: Łączniki zbrozczkoma

Typ (odmioty): AZH, AZH-100, AZH-C, AZH-S, AZH-S PLUS, AWZ, AWZ-3), AZ-B, AZ-B PLUS, AZ-112, AZ-112 PLUS.

Podstawowe parametry: znamionowa napięcie: AC 230 V, 50 Hz;  
znamionowy prąd: 10 A - AZH, AZH-C;  
10 A - AZH-100, AWZ, AZH-S, AZH-S PLUS, AZ-B, AZ-B PLUS, AZ-112, AZ-112 PLUS;  
30 A - AWZ-3E;  
stopień ochrony obudowy: IP40, IP66;  
wyposażenie: sonda zewnętrzna hermetyczna PLUS

Symbol klasyfikacji: SWAY-1151-2 PN/NB: 31.20.27-90.00

Wyrób spełnia wymagania bezpieczeństwa zawarte w: PN-EN 60669-1:2002 +A1:2003, EN 60669-1:1999 +A1:2003  
PN-EN 60669-2-1:2002, EN 60669-2-1:2000 +A2:2001

Nr sprawozdania: TA 4.67

Model certyfikacji: MODEL 6 ISO

Prawo do oznaczenia w okresie od 2004-04-30 do 2008-04-29 dotyczy wyłącznie egzemplarzy wyrobów posiadających identyczne właściwości (parametry) jak przedmiotowy do badań wcale (testy) i odpowiadających wymaganiom określonym powyżej.

Prawa i obowiązki obu stron wyliczające z niniejszego certyfikatu określa odrębna umowa.

Zastępuje certyfikat nr B/12/451/2003

Warszawa, data: 2004-04-30

 Piotr Łuski

We declare  
that the conformity of our products  
with the requirements  
of the  
CE and B  
labelling procedures  
has been confirmed with tests  
carried out  
by  
**Biuro Badawcze ds. Jakości  
SEP Warszawa**  
within the scope  
of the  
Low Voltage Directive  
by a  
laboratory in Lublin  
and  
in terms  
of the Electromagnetic Compatibility Directive  
by  
**Instytut Elektrotechniki Politechniki  
Wrocławskiej**

All concerned parties  
may receive  
the copies of conformity  
certificates CE  
and  
B-label security certificates  
concerning our products  
via mail or fax.  
Printable versions of these documents  
may also be found  
in our  
internet site  
**www.fif.com.pl**

**DEKLARACJA ZGODNOŚCI WE**  
Nr 006/04

Niżej podpisany, reprezentujący niżej wymienionego producenta

Producent: <<F&F>> Filpowski S. J.  
Regon 470625215  
NIP 731 700 53 14

Adres: 95-200 Pabianice  
ul. Konstancyńska 79/81  
tel./fax (+48 22 709 7 11) / (+22) 152 36 3

niżej podpisany, deklaruje, że wyrób  
Identyfikacja wyrobu  
**Automatyczne przełączniki faz**  
Typy: PF 401, PF 441, PF 461

Jest zgodny z postanowieniami następującej dyrektywy (dyrektyw) WE  
(łącznie ze wszystkimi jej zmianami i uzupełnieniami)

Nr dyrektywy do numeru	Typ
LVD 73/23/EEWG	Dyrektywa niskonapięciowa
EMC 89/336/EEWG	Dyrektywa dotycząca kompatybilności elektromagnetycznej

I że zastosowano normy i/lub dokumentacja techniczne wymienione na rewersie deklaracji.  
Ostatnie dwie cyfry roku, w którym nanesiono oznaczenie CE: **05**

Pabianice	29.03.2004	 <b>F &amp; F</b> FILPOWSKI Spółka Jawna ul. Konstancyńska 79/81 95-200 Pabianice, Regon 470625215 NIP 731 700 53 14	Sławomir Grzegorzewski  Dyrektor techniczny
miejsce i data	data		

# P R O D U C T I O N   O F F E R

<b>LIGHT DEPENDENT RELAYS</b>	<b>1</b>
<b>STAIRCASE TIMERS</b>	<b>2</b>
<b>ELECTRONIC BI-STABLE PULSE RELAYS</b>	<b>3</b>
<b>LIGHT DIMMERS</b>	<b>4</b>
<b>LIGHTING CONTROLER</b>	<b>5</b>
<b>RADIO CONTROL RELAYS</b>	<b>6</b>
<b>MOTION SENSOR SWITCH</b>	<b>7</b>
<b>ROLLER BLIND CONTROLLERS</b>	<b>8</b>
<b>PHASE CONTROL RELAYS</b>	<b>9</b>
<b>VOLTAGE RELAYS</b>	<b>10</b>
<b>AUTOMATIC PHASE SWITCH</b>	<b>11</b>
<b>AUTOMATIC TRANSFER SWITCHING EQUIPMENT</b>	<b>12</b>
<b>TIMING RELAY</b>	<b>13</b>
<b>TIME CONTROLLERS</b>	<b>14</b>
<b>PROGRAMMABLE CONTROL TIMER</b>	<b>15</b>
<b>POWER CONSUMPTION LIMITER</b>	<b>16</b>
<b>PRIORITY RELAYS</b>	<b>17</b>
<b>CURRENT RELAYS</b>	<b>18</b>
<b>FUSE MODULES</b>	<b>19</b>
<b>RELAY FOR ELECTRIC ENGINES</b>	<b>20</b>
<b>ELECTRIC SUPPLIERS AND TRANSFORMERS</b>	<b>21</b>
<b>POWER SUPPLY INDICATORS</b>	<b>22</b>
<b>METERS</b>	<b>23</b>
<b>FLUID LEVEL CONTROL RELAYS</b>	<b>24</b>
<b>TEMPERATURE REGULATORS</b>	<b>25</b>
<b>CONTROL SYSTEM COMPONENTS</b>	<b>26</b>
<b>SIGNAL TRANSMITTERS</b>	<b>27</b>
<b>CURRENT TRANSFORMER</b>	<b>28</b>
<b>VIDEO INTERCOM SETS</b>	<b>29</b>
<b>INTELLIGENT HOUSE SYSTEM F&amp;Home</b>	<b>30</b>
<b>PROGRAMMABLE LOGIC CONTROLLERS MAX</b>	<b>31</b>
<b>ENCLOSURE DIMENSIONS</b>	<b>32</b>

# 1.

# LIGHT DEPENDENT RELAYS

## PURPOSE

Light dependent relay serves to switch-ON the lighting of streets, squares, shop windows, neon lamps etc, at twilight and to switch-OFF afore mentioned lighting at dawn.

## FUNCTIONING

The relay should be situated at place with permanent access to day light, which, due to its changes of intensity, will cause switching ON and OFF the lighting. The exact time of switching the lighting can be set by potentiometer by the user. Turn in the direction of "half moon" will delay switching-ON, turning in the direction of "sun" will advance switching-ON. The relay is equipped with a delay system, which delays switching ON and OFF the lighting, thus eliminating the influence of accidental disturbances like thunder lightings on the relay functioning.

## WITH INTERNAL LIGHT DEPENDENT SENSOR

### AZH

10A. Hermetic.

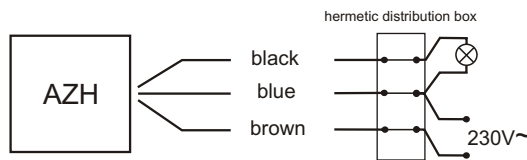

supply	230V AC
current load	<10A
switching threshold (setting range)	2÷1000Lx
switching threshold (factory setting)	ok. 7Lx
histeresis	ok. 15Lx
switching ON delay	1÷15sec
switching OFF delay	10÷30sec
power consumption	0,56W
connection cable	cablе 3×0,75mm <sup>2</sup> ; l=0,8m
working temperature	-25÷50°C
dimensions	50×67×26mm
fixing	two screws to substrate
protection level	IP65

### AZH-106

16A. Hermetic.

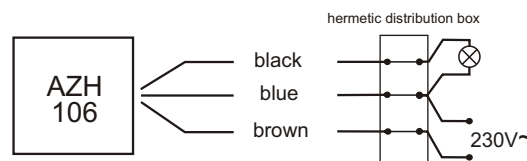

supply	230V AC
current load	<16A
switching threshold (setting range)	2÷1000Lx
switching threshold (factory setting)	ok. 7Lx
histeresis	ok. 15Lx
switching ON delay	1÷15sec
switching OFF delay	10÷30sec
power consumption	0,56W
connection cable	cablе 3×1mm <sup>2</sup> ; l=0,8m
working temperature	-25÷50°C
dimensions	50×67×26mm
fixing	two screws to substrate
protection level	IP65

### AZH-C

10A. Miniature. Hermetic.

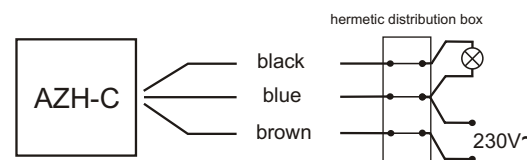

supply	230V AC
current load	<10A
switching threshold (setting range)	2÷1000Lx
switching threshold (factory setting)	ok. 7Lx
histeresis	ok. 15Lx
switching ON delay	1÷15sec
switching OFF delay	10÷30sec
power consumption	0,56W
connection cable	cablе 3×0,75mm <sup>2</sup> ; l=0,5m
working temperature	-25÷50°C
dimensions	81×33×25mm
fixing	two screws to substrate
protection level	IP65

**AWZ** 16A. Hermetic. With internal connection.  
**AWZ-30** 30A. Hermetic. With internal connection.



Light dependent relay in box with special sealing flange, fastened to the substrate by two screws, closed by a cover with silicon gasket and tightened by 4 screws.

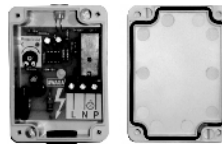
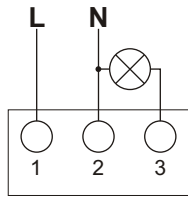

supply	230V AC
current load	<16A
switching threshold (setting range)	2÷1000Lx
switching threshold (factory setting)	ok. 7Lx
hysteresis	ok. 15Lx
switching ON delay	1÷15sec
switching OFF delay	10÷30sec
power consumption	0,8W
connection	screw terminals 2,5mm <sup>2</sup>
working temperature	-25÷50°C
dimensions	60×85×35mm
fixing	two screws to substrate
protection level	IP65

## WITH EXTERNAL HERMETIC PROBE

### AZH-S / AZH-S PLUS

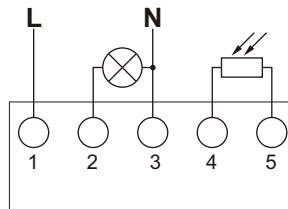

External hermetic probe Ø10 or PLUS (see item 1/9) including with automatic twilight sensor.

supply	230V AC
current load	<16A
switching threshold (setting range)	2÷1000Lx
switching threshold (factory setting)	ok. 7Lx
hysteresis	ok. 15Lx
switching ON delay	1÷15sec
switching OFF delay	10÷30sec
power consumption	0,56W
connection	screw terminals 2,5mm <sup>2</sup>
working temperature	-25÷50°C
dimensions	50×67×26mm
fixing	two screws to substrate

### AZ-B / AZ-B PLUS AZ-B UNI / AZ-B PLUS UNI

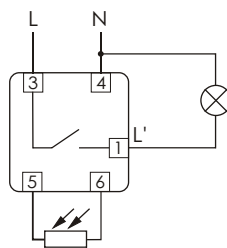

External hermetic probe Ø10 or PLUS (see item 1/9) including with automatic twilight sensor.

supply	AZ-B / AZ-B PLUS	230V AC
	AZ-B UNI / AZ-B PLUS UNI	12÷264V AC/DC
current load		<16A
switching threshold (setting range)		2÷1000Lx
switching threshold (factory setting)		ok. 7Lx
hysteresis		ok. 15Lx
switching ON delay		1÷15sec
switching OFF delay		10÷30sec
power consumption		0,56W
connection		screw terminals 2,5mm <sup>2</sup>
working temperature		-25÷50°C
dimensions		2 modules (35mm)
fixing		on rail TH-35

### AZ-112 / AZ-112 PLUS

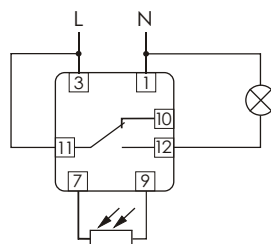

External hermetic probe Ø10 or PLUS (see item 1/9) including with automatic twilight sensor.

supply	230V AC
contact	1N/O
current load	<16A
switching threshold (setting range)	2÷1000Lx
switching threshold (factory setting)	ok. 7Lx
hysteresis	ok. 15Lx
switching ON delay	1÷15sec
switching OFF delay	10÷30sec
power consumption	0,8W
connection	screw terminals 2,5mm <sup>2</sup>
working temperature	-25÷50°C
dimensions	1 module (18mm)
fixing	on rail TH-35

# Hermetic external probe

## PLUS

Applied in sets: AZH-S PLUS, AZ-B PLUS, AZ-112 PLUS.  
Available separately.

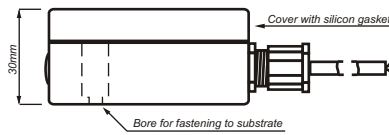
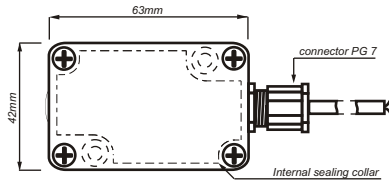

Optical sensor in convenient low dimensioned casing, to be connected by connector PG7 with round cable  $\varnothing_{max} 7$  mm, (for ex.  $2 \times 0,5 \text{mm}^2$ ) of length acc to necessity, Box with special sealing flange, fastened to the substrate by two screws, closed by a cover with silicon gasket and tightened by 4 screws.

## Ø10

Applied in sets: AZH-S, AZ-B, AZ-112.  
Available separately.

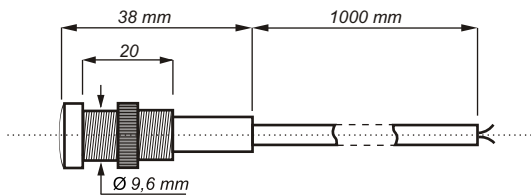

Little, easy to mount light dependent sensor with 1 meter cable with possibility to extend (connection of leads should be made in hermetic distribution box or at a place free from atmospheric influence).

### ATTENTION!

The external probe should be situated at place with permanent access to day light, which, due to its changes of intensity, will cause switching ON and OFF the lighting.  
When length of connecting cable of external probe exceeds 10m it should not be laid in vicinity of a parallel conductor under mains voltage, or conducting great currents. In any case always connect correctly phase and neutral leads to the light dependent relay.

### PRACTICAL SOLUTIONS

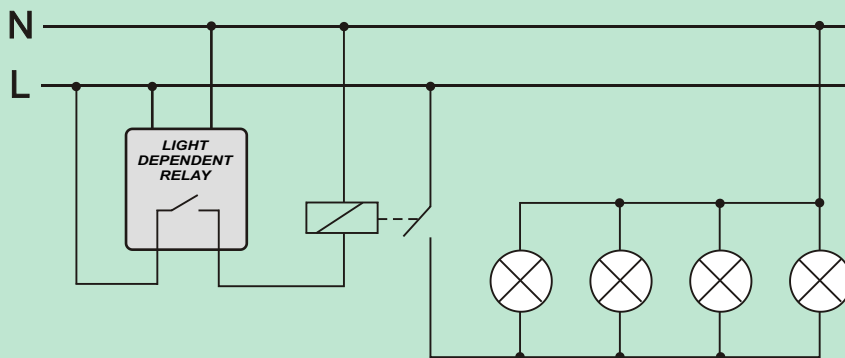

Control system for contactor-actuating receivers of total power consumption exceeding the maximum allowable load of a photo-sensitive switch.

### ATTENTION!

Automatic twilight sensors for other voltages than specified in the technical data table are also available on special request (24V, 48V, and 110V AC/DC and other).

## 2.

# STAIRCASE TIMERS

### PURPOSE

Staircase timer serves to keep switched-ON lighting of staircase, corridor, or any other object for the set time and to switch-OFF this lighting automatically, upon elapse of this set time.

### FUNCTIONING

Turned ON staircase timer supports the lighting during set time by potentiometer (from 0,5min. to 10min.). After passage of set time timer will switch OFF the lighting automatically. After switching OFF the lighting there is possibility to switch it ON again.

## STANDART TYPE

### ASO-220 / ASO-24

10A. With cable connection.

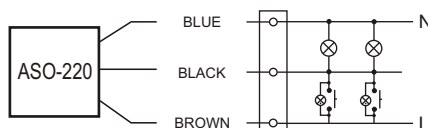

supply ASO-220	230V AC
ASO-24	24V AC/DC
current load	<10A
switching OFF delay (to set)	0,5+10m
switching ON delay	<1sec
power consumption	0,56W
connection	cable 3×0,75mm <sup>2</sup> ; l=0,45m
working temperature	-25+50°C
dimensions	50×67×26mm
fixing	two screws to substrate

ASO-220 is adapted to co-operate with pushbuttons equipped with neon lamp.

### ASO-201 / ASO-204

16A. With screw terminals.

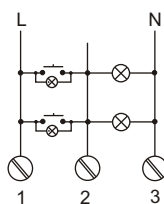

supply ASO-201	230V AC
ASO-204	24V AC/DC
current load	<16A
switching OFF delay (to set)	0,5+10m
switching ON delay	<1sec
power consumption	0,56W
connection	screw terminals 2,5mm <sup>2</sup>
working temperature	-25+50°C
dimensions	50×67×26mm
fixing	two screws to substrate

ASO-201 is adapted to co-operate with pushbuttons equipped with neon lamp.

### ASO-205

10A. To under plaster box.

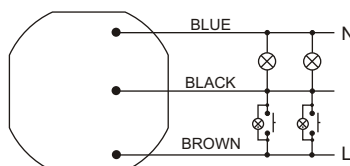

supply	230V AC
current load	<10A
switching OFF delay (to set)	0,5+10m
switching ON delay	<1sec
power consumption	0,4W
connection	wires 3×1mm <sup>2</sup> ; l=10cm
working temperature	-25+50°C
dimensions	Ø55, h=13mm
fixing	to under plaster box Ø60

ASO-205 is adapted to co-operate with pushbuttons equipped with neon lamp.

## AS-B220 / AS-B24

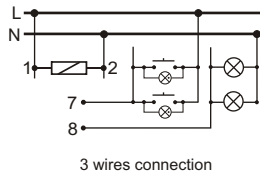
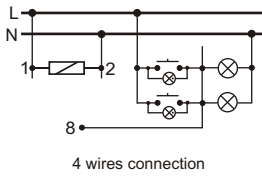

supply AS-B 220	230V AC
AS-B24	24V AC/DC
current load	<16A
switching OFF delay (to set)	0,5+10m
switching ON delay	<1sec
power consumption	1,2W
connection	screw terminals 2,5mm <sup>2</sup>
working temperature	-25+50°C
dimensions	2 modules (35mm)
fixing	on rail TH-35

AS-B 220 is adapted to co-operate with pushbuttons equipped with neon lamp.

## AS-212 / AS-214

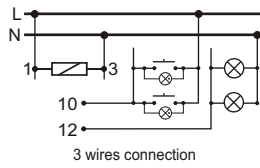
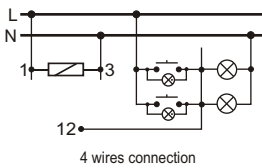

supply AS-212	230V AC
AS-214	24V AC/DC
current load	<16A
switching OFF delay (to set)	0,5+10m
switching ON delay	<1sec
power consumption	0,56W
connection	screw terminals 2,5mm <sup>2</sup>
working temperature	-25+50°C
dimensions	1 module (18mm)
fixing	on rail TH-35

AS-212 is adapted to co-operate with pushbuttons equipped with neon lamp.

## WITH ADDITIONAL FUNCTION OF COUNTER-BLOCKADE

Function of counter blockade does not allow to keep the light-ON in case of staircase switch blocking (after blocking the pushbutton, for example by match, the timer will count the set time and switch OFF the lighting). Next switching ON can be after removing the blockade.

## ASO-202 / ASO-203

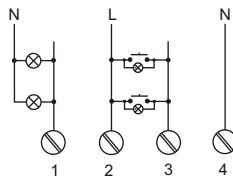

supply ASO-202	230V AC
ASO-203	24V AC/DC
current load	<16A
switching OFF delay (to set)	0,5+10m
switching ON delay	<1sec
power consumption	0,56W
connection	screw terminals 2,5mm <sup>2</sup>
working temperature	-25+50°C
dimensions	50×67×26mm
fixing	two screws to substrate

ASO-202 is adapted to co-operate with pushbuttons equipped with neon lamp.

## AS-223 / AS-224

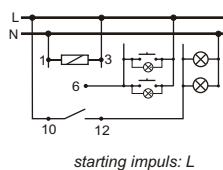
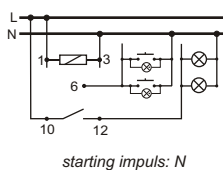

supply AS-223	230V AC
AS-224	24V AC/DC
current load	<16A
switching OFF delay (to set)	0,5+10m
switching ON delay	<1sec
power consumption	0,56W
connection	screw terminals 2,5mm <sup>2</sup>
working temperature	-25+50°C
dimensions	1 module (18mm)
fixing	on rail TH-35

AS-223 is adapted to co-operate with pushbuttons equipped with neon lamp.



## WITH FUNCTION OF SIGNALISATION OF LIGHTING SWITCHING-OFF.

### AS-221T

Turned ON staircase timer supports the lighting during set time by potentiometr (from 0,5min. to 10min.) and upon elapse of this set time a reduction by half of lighting brightness follows for about 30 seconds, after that OFF follows (thus an occurrence of a sudden darkness is avoided, enabling safe approach to the switch). After switching OFF the lighting there is possibility to switch it ON again.

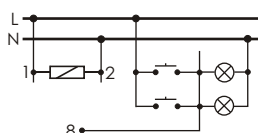

4 wires connection

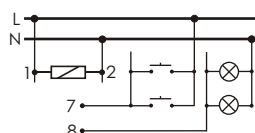

3 wires connection

supply	230V AC
current load	<10A
switching OFF delay (to set)	0,5÷10m
switching ON delay	<1sec
time of reduced brightness	~30sec
power consumption	0,8W
connection	screw terminals 2,5mm <sup>2</sup>
working temperature	-25÷50°C
dimensions	2 modules (35mm)
fixing	on rail TH-35

#### ATTENTION!

The AS-221T is not compatible with glow-discharge tubes, compact fluorescent lamps and other lighting devices including electric starters.

### AS-222T

#### WITH COUNTER BLOCKADE

Turned ON staircase timer supports the lighting during set time by potentiometer (from 0,5min. to 10min.) and upon elapse of this set time a reduction by half of lighting brightness follows for about 30 seconds, after that OFF follows (thus an occurrence of a sudden darkness is avoided, enabling safe approach to the switch). Function of counter blockade does not allow to keep the light-ON in case of staircase switch blocking (after blocking the pushbutton, for example by match, the timer will count the set time and switch OFF the lighting). Next switching ON can be after removing the blockade.

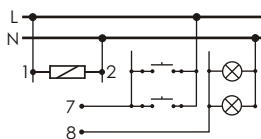

supply	230V AC
current load	<10A
switching OFF delay (to set)	0,5÷10m
switching ON delay	<1sec
time of reduced brightness	~30sec
power consumption	0,8W
connection	screw terminals 2,5mm <sup>2</sup>
working temperature	-25÷50°C
dimensions	2 modules (35mm)
fixing	on rail TH-35

#### ATTENTION!

The AS-222T is not compatible with glow-discharge tubes, compact fluorescent lamps and other lighting devices including electric starters.

#### ATTENTION!

Automatic staircase switches for other voltages than specified in the technical data table are also available on special request (12V, 48V, and 110V AC/DC and other). The offer does not include the AS-221T and AS-222T models.

# 3. ELECTRONIC BI-STABLE PULSE RELAYS

## PURPOSE

Electronic bi-stable pulse relays enables the user to actuate lighting or other devices from various locations by means of control buttons in parallel connection.

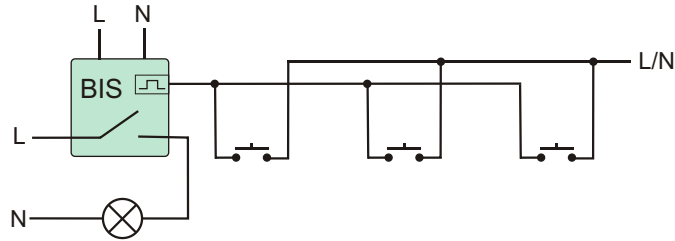

## SWITCH ON - SWITCH OFF TYPE

### FUNCTIONING

The receiver is actuated by means of a current pulse triggered by pushing any bell push connected to the relay. The receiver is deactivated by another pulse or after a preset time.

The relay does not "memorize" the position of the relay contact, i.e. in case of supply voltage decay and the subsequent return of supply voltage, the relay contact will be set in the off position. Such a solution prevents the automatic actuation of the receivers controlled that might occur without proper supervision after a long-lasting decay of supply voltage.

## BIS-402

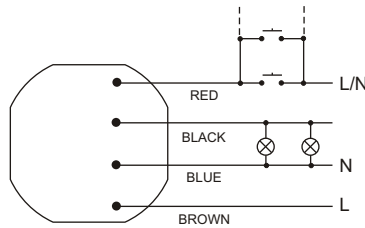

supply	230V AC
current load	<10A
controlling current	0,5+1mA
activation delay	0,1+0,2sec
power consumption	0,4W
connection	wires 4x1mm <sup>2</sup> ; l=10cm
working temperature	-25+50°C
dimensions	Ø55, h=13mm
fixing	to under plaster box Ø60

### ATTENTION!

The BIS-402 is not compatible with bell pushes equipped with fluorescent lamps.

## BIS-411

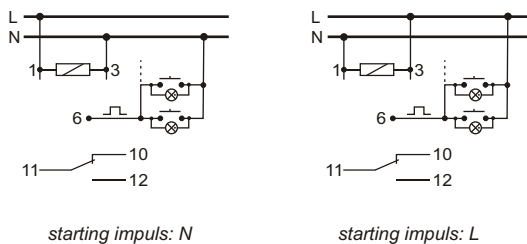

supply	230V AC
current load	<10A
controlling current	0,5+1mA
activation delay	0,1+0,2sec
sygnalling of supply	green LED
sygnalling of activation	red LED
power consumption	0,8W
connection	screw terminals 2,5mm <sup>2</sup>
working temperature	-25+50°C
dimensions	1 module (18mm)
fixing	on rail TH-35

### ATTENTION!

The BIS-411 is compatible with bell pushes equipped with fluorescent lamps.

## WITH TIMING SWITCH

### FUNCTIONING

The receiver is actuated by means of a current pulse triggered by pushing any bell push connected to the relay. The receiver is deactivated by another pulse or after a preset time.

Press and hold the control button longer then 2 sec, that will effect the activate lighting permanently until the next pulse which will turn off the relay.

The relay does not "memorize" the position of the relay contact, i.e. in case of supply voltage decay and the subsequent return of supply voltage, the relay contact will be set in the off position. Such a solution prevents the automatic actuation of the receivers controlled that might occur without proper supervision after a long-lasting decay of supply voltage.

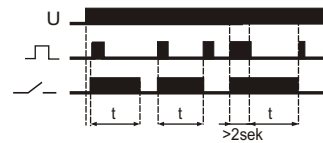

## BIS-403

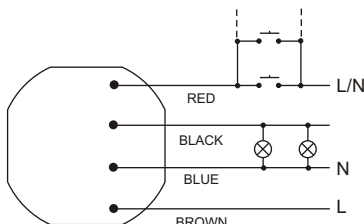

supply	230V AC
current load	<10A
controlling current	<1mA
activation delay	0,1+0,2sec
switching OFF delay (to set)	1+12min
power consumption	0,4W
connection	wires 4×1mm <sup>2</sup> ; l=10cm
working temperature	-25+50°C
dimensions	Ø55, h=13mm
fixing	to under plaster box Ø60

### ATTENTION!

The BIS-403 is not compatible with bell pushes equipped with fluorescent lamps.

## BIS-413

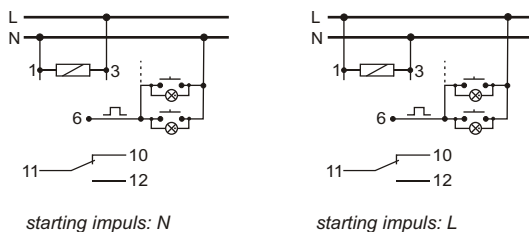

supply	230V AC
current load	<10A
controlling current	0,5÷1mA
activation delay	0,1+0,2sec
switching OFF delay (to set)	1+12min
sygnalling of supplay	green LED
sygnalling of activation	red LED
power consumption	0,8W
connection	screw terminals 2,5mm <sup>2</sup>
working temperature	-25+50°C
dimensions	1 module (18mm)
fixing	on rail TH-35

### ATTENTION!

The BIS-413 is not compatible with bell pushes equipped with fluorescent lamps.

### PRACTICAL SOLUTIONS

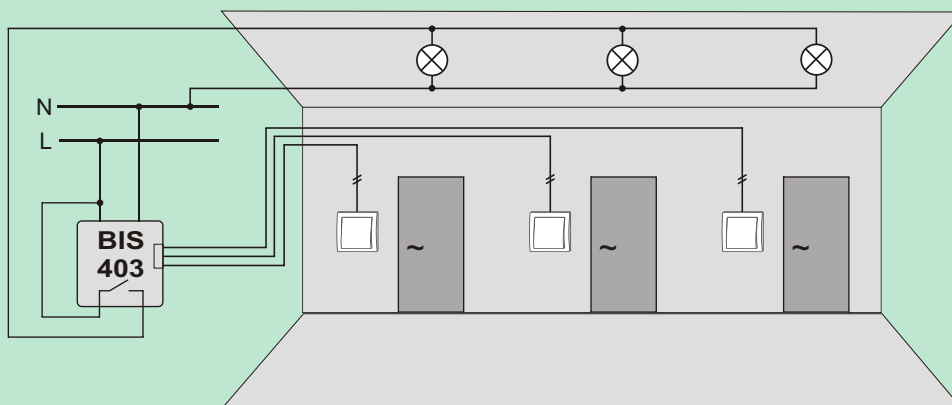

Example of control system for three-point hall lighting.

# SEQUENCE-TYPE

## FUNCTIONING

Switching the relay into another cycle phase is made by another current pulse triggered by pressing any bell push connected to the relay.

The relay does not “memorize” the position of the relay contact, i.e. in case of supply voltage decay and the subsequent return of supply voltage, the relay contact will be set in the off position. Such a solution prevents the automatic actuation of the receivers controlled that might occur without proper supervision after a long-lasting decay of supply voltage.

PULSE	STATE OF FUNCTIONING
1	ACTIVATED ONLY SECTION R1
2	ACTIVATED ONLY SECTION R2
3	ACTIVATED SECTION R1 AND R2
4	DEACTIVATED SECTION R1 AND R2

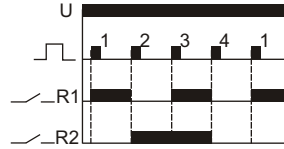

## BIS-404

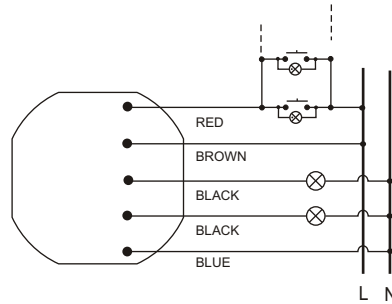

supply	230V AC
contacts	2×1N/O
current load	2×(<5A)
controlling current	0,5±1mA
activation delay	0,1±0,2sec
power consumption	0,56W
connection	wires 5×1mm <sup>2</sup> ; l=10cm
working temperature	-25+50°C
dimensions	Ø55, h=13mm
fixing	to under plaster box Ø60

### ATTENTION!

The BIS-404 is not compatible with bell pushes equipped with fluorescent lamps.

## BIS-414

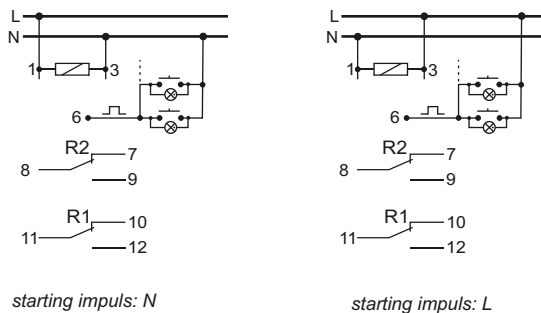

supply	230V AC
contacts	2×1N/O
current load	2×(<10A)
controlling current	0,5±1mA
activation delay	0,1±0,2sec
switching OFF delay (to set)	1±12min
signalling of supply	green LED
signalling of activation	2×yellow LED
power consumption	0,8W
connection	screw terminals 2,5mm <sup>2</sup>
working temperature	-25+50°C
dimensions	1 module (17,5mm)
fixing	on rail TH-35

### ATTENTION!

The BIS-414 is not compatible with bell pushes equipped with fluorescent lamps.

### PRACTICAL SOLUTIONS

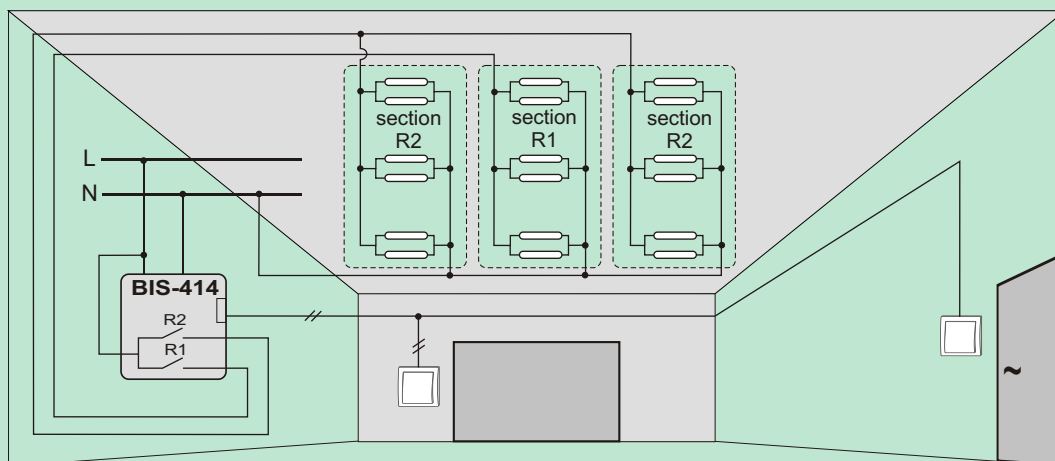

Example of lighting system which allows control of light intensity by actuating one of the sections R1 and R2 from any location in the room.

# GROUP-TYPE (HOTEL-TYPE)

## BIS-412 WITH CONTROLLING INPUTS 'ACTIVATE ALL' AND 'DEACTIVATE ALL'

### FUNCTIONING

BIS-412 electronic bi-stable pulse relay is designed for operation in a group configuration. A single relay enables the activation and deactivation of the receiver controlled after each current pulse triggered by pushing a local control momentary push-button (bell-push). The group configuration enables the deactivation or activation of all receivers connected to individual relays by means of the central control push-buttons

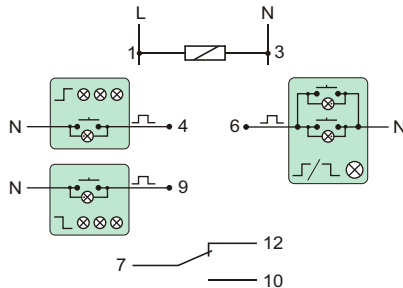

supply BIS-412 230V	230V AC
BIS-412 24V	24V AC/DC
current load	<16A
controlling current	0,5÷1mA
activation delay	0,1÷0,2sec
signalling of supply	green LED
signalling of activation	red LED
power consumption	0,8W
connection	screw terminals 2,5mm <sup>2</sup>
working temperature	-25÷50°C
dimensions	1 module (18mm)
fixing	on rail TH-35

#### Local control

The receiver is activated after a current pulse that is triggered by pushing one optional momentary push-button  $\text{J/L} \otimes$  belonging to the local control group. The contact of the relay is switched to the 7-10 position. After a next current pulse, the receiver will be deactivated (the contact of the relay returns to the 7-12 position).

#### Central control

**DEACTIVATE ALL** - after a current pulse triggered by pushing the  $\text{L} \otimes \otimes \otimes$  momentary push-button, all receivers will be deactivated (regardless of their status, i.e. deactivation or activation) that are controlled separately by individual relays. The contact in each relay will be switched to the 7-12 position.

**ACTIVATE ALL** - after a current pulse triggered by pushing the  $\text{J} \otimes \otimes \otimes$  momentary push-button, all receivers will be activated (regardless of their status, i.e. deactivation or activation) that are controlled separately by individual relays. The contact in each relay will be switched to the 7-10 position.

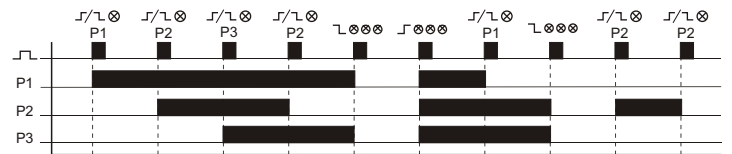
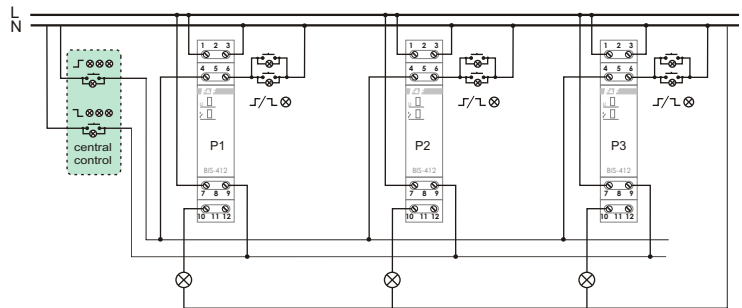

Diagram

### ATTENTION!

The BIS-412 230V is compatible with bell pushes equipped with fluorescent lamps.

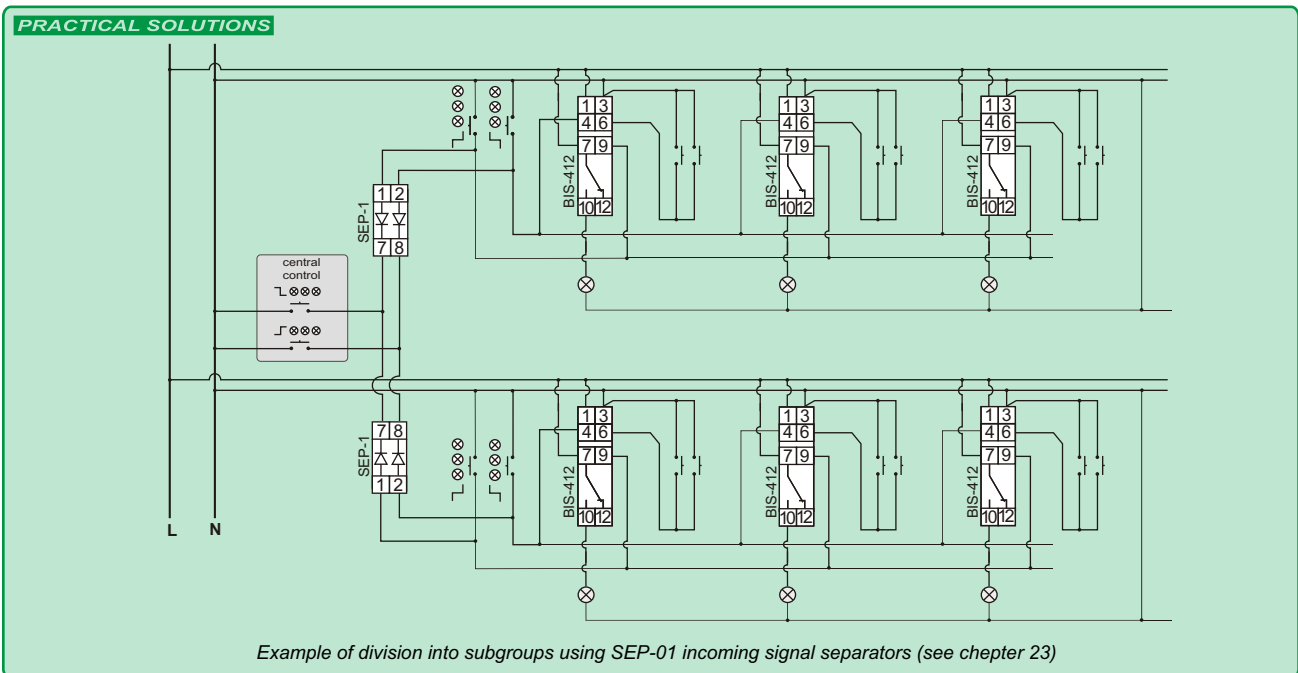

Example of division into subgroups using SEP-01 incoming signal separators (see chepter 23)

# 4.

# LIGHT DIMMERS

**PURPOSE**

the dimmer is used for switching on and off lighting and offers the option of light intensity adjustment by means of any impulse switch (buzzer).

**FUNCTIONING**

Lighting is turned on by a current pulse sent after pressing an impulse switch (buzzer) connected to a relay. Another impulse switches the lighting off. Pressing and holding the switch for more than 1 second allows the user to adjust light intensity (continuous loop adjustments in the following sequence: BRIGHTER→DARKER→BRIGHTER).

Light intensity may be controlled by means of numerous switches in a parallel connection, distributed in several locations within a room.

SCO are adapted to co-operate with pushbuttons equipped with neon lamp.

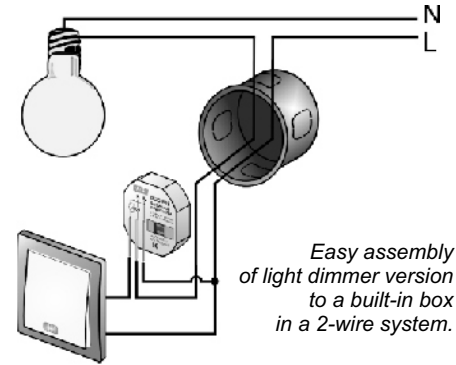

## SUITABLE FOR INCANDESCENT AND HALOGEN LAMPS

(including those powered with electronic or transformer-based feeders adapted to dimmers).

### NO "STORAGE" OF LIGHT INTENSITY SETTINGS ENABLED.

The lighting returns to its maximum intensity after each activation.

#### SCO-801 350W

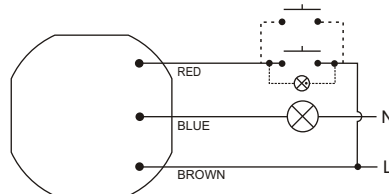

supply	230V AC
current load	<1,5A
maximum power of light bulbs connected	350 W
current pulse duration	<1sec
power consumption	0,1W
working temperature	-25+50°C
connection	wires 3×1mm <sup>2</sup> , l=10cm
dimensions	Ø55, h=13mm
fixing	to under plaster box Ø60mm
overcurrent protection	WTA 5×20 fuse link 2A

#### SCO-811 350W

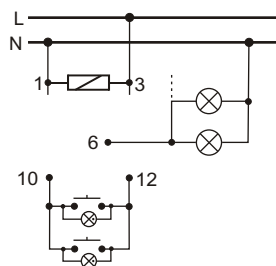

supply	230V AC
current load	<1,5A
maximum power of light bulbs connected	350 W
current pulse duration	<1sec
power consumption	0,1W
working temperature	-25+50°C
connection	screw terminals 2,5mm <sup>2</sup>
dimensions	1 module (18mm)
fixing	on rail TH-35
overcurrent protection	WTA 5×20 fuse link 2A

#### SCO-813 1000W

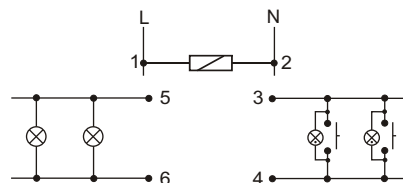

supply	230V AC
current load	<4,5A
maximum power of light bulbs connected	1000 W
current pulse duration	<1sec
power consumption	0,3W
working temperature	-25+50°C
connection	screw terminals 2,5mm <sup>2</sup>
dimensions	3 modules (52,5mm)
fixing	on rail TH-35
overcurrent protection	WTA 5×20 fuse link 6,3A

**ATTENTION!**

"SOFT START" - pressing and holding the switch for more than 1 second on switch-on allows gradual increase of the intensity from "zero level" (in a DARKER→BRIGHTER sequence).

**A FUNCTION OF LIGHT INTENSITY SETTING “STORAGE” ALLOWED.**

The lighting returns to the preset intensity after each activation.

**SCO-802 350W**

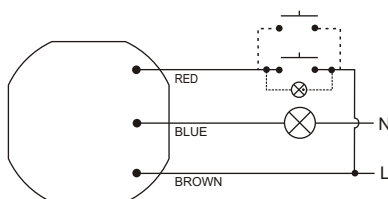

supply	230V AC
current load	<1,5A
maximum power of light bulbs connected	350 W
current pulse duration	<1sec
power consumption	0,1W
working temperature	-25+50°C
connection	wires 3×1mm <sup>2</sup> , l=10cm
dimensions	Ø55, h=13mm
fixing	to under plaster box Ø60mm
overcurrent protection	WTA 5×20 fuse link 2A

**SCO-812 350W**

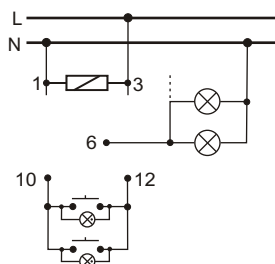

supply	230V AC
current load	<1,5A
maximum power of light bulbs connected	350 W
current pulse duration	<1sec
power consumption	0,1W
working temperature	-25+50°C
connection	screw terminals 2,5mm <sup>2</sup>
dimensions	1 module (18mm)
fixing	on rail TH-35
overcurrent protection	WTA 5×20 fuse link 2A

**SCO-814 1000W**

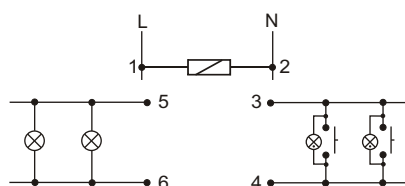

supply	230V AC
current load	<4,5A
maximum power of light bulbs connected	1000 W
current pulse duration	<1sec
power consumption	0,3W
working temperature	-25+50°C
connection	screw terminals 2,5mm <sup>2</sup>
dimensions	3 modules (52,5mm)
fixing	on rail TH-35
overcurrent protection	WTA 5×20 fuse link 6,3A

**LIGHTING DIMMERS LED 12V**  
with “storage” of light intensity settings enabled

**SCO-803 36W**

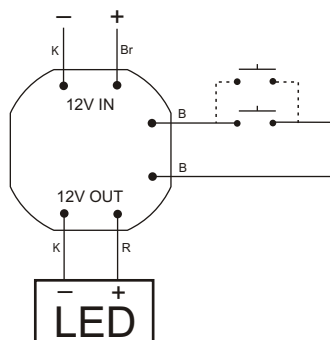

supply	12V DC
maximum power of connected LED	<36W
current pulse duration	<1sec
power consumption	0,1W
working temperature	-25+50°C
connection	6×LY 0,75mm, l=10cm
dimensions	Ø55, h=13mm
fixing	to under plaster box Ø60

# LIGHT DIMMER

Used for incandescent lamps, halogen lamps, compact fluorescent lamps with the dimming possibility

## SCO-815

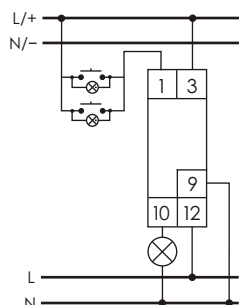

supply	230V AC
maximum power of light bulbs connected	
(R)	500W
(L)	500W
(C)	500W
(ESL)	100W
control voltage	8÷230V AC/DC
current pulse duration	<1sek
power consumption	0,1W
working temperature	-20÷50°C
connection	screw terminals 2,5mm <sup>2</sup>
dimensions	1 modul (18mm)
fixing	on rail TH-35

### PURPOSE

Universal lighting dimmer enables you to adjust the brightness of light the following light sources:

- Incandescent lamps and halogen main series (resistive load R)
- Lamps powered by a toroidal supplier (inductive load L)
- Lamps powered by electronic transformer (capacitive load C)
- Energy-saving compact fluorescent lamps (ESL) with dimming function

### FUNCTIONING

The inclusion of light followed by a current pulse caused by a momentary push button (bell) connected to the relay. Lighting can be controlled through a number of buttons arranged in parallel at different points in the building. Disabling lighting will be after the next impulse. Holding down the button, > 1sec. enables you to set the desired light intensity (continuously adjustable lighting in the loop, Lighter / Darker / Lighter).

### FUNCTIONS

- Automatic detection of the nature of the load L+R and R+C. The use of ESL lamps requires manual settings for nature of the load with dimmer knob on the forehead.
- Speed setting for brightness adjustment.
- "Memory" light intensity settings - after each inclusion lighting returns to the desired brightness.
- Function "SOFT START" - holding the button > 1sec. at switch on lights causes the smoothly illumination from "zero" (dark → bright).
- Setting a minimum level of light-controlled lamps (particularly important for ESL lamps, requiring a minimum current of ignition and sustain).
- ON mode - switching to the maximum brightness of lighting without dimming.
- Control input galvanically isolated from the network with a wide range of input voltage 8 ÷ 230V AC / DC.
- Continuously adjustable lighting up and down in order to prolong the life of controlled lamp.

### PRACTICAL SOLUTIONS

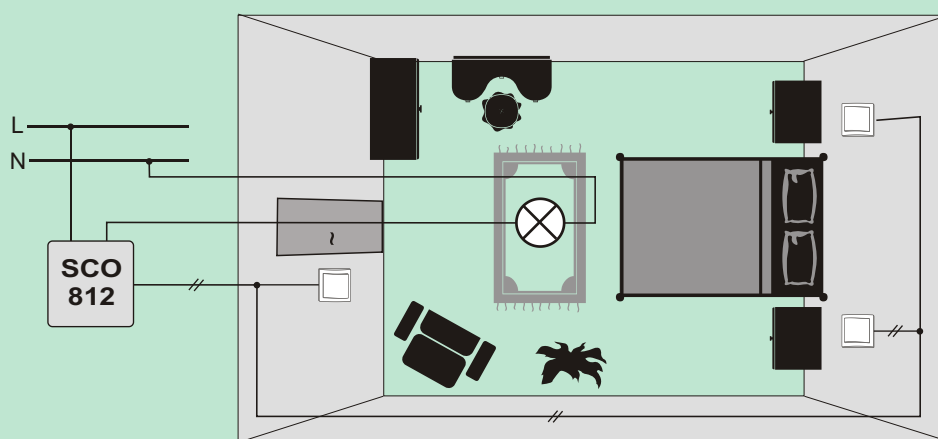

Example of lighting control system from three locations within a room.



# 5. LIGHTING CONTROLLER

## POWER LED DRIVER PLD-01 1W / 3W

### PURPOSE

LED power supply requires a suitable source of supply. In the case of current exceeding a specified value followed by a deterioration of work performance LED. PLD-01 is used to stabilize the output current of power diodes.

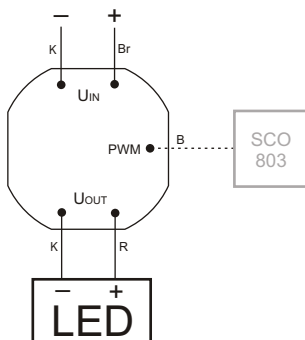

input voltage IN	5+40V DC
power of connected LED	
LED 1W	15W
LED 3W	30W
maks. prąd stabilizowany wyjściowy	
LED 1W	350mA
LED 3W	750mA
power consumption	0,1W
working temperature	-20+50°C
connections	5×LY 0,75mm <sup>2</sup> , l=10cm
dimensions	Ø55, h=13mm
fixing	in under plaster box Ø60

### ATTENTION!

PLD-01 cooperate with dimmer LED SCO-803 (part. 4).

## "SOFT START" FOR HALOGEN LAMP

### PURPOSE

MST is used to reduce the starting current of halogen lamps. This prevents over-connected lamps, in effect extending their service life.

### FUNCTIONING

At the time of switching on the controller does not allow for immediate switch ON of light to full power. Initially the lamp system is powered by internal thermistor which limiting current circuit. After a time of 1sec. system switches to permanent contact, through which passes a full load of receivers. ATTENTION! No effect gradually illuminating of lamps.

## MST-01

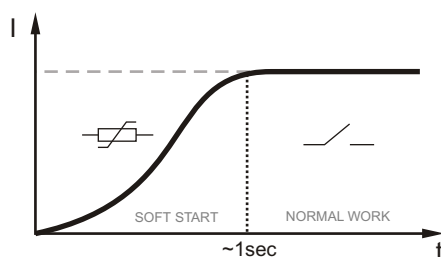

input Voltage	230V AC
output Voltage	230V AC
contact	1Z
current load	8A
rise time	1sec
power consumption of detection sensor	0,1W
working temperature	-25+50°C
connection	screw terminals 2,5mm <sup>2</sup>
dimensions	1 module (18mm)
fixing	on the rail TH-35

## MST-02

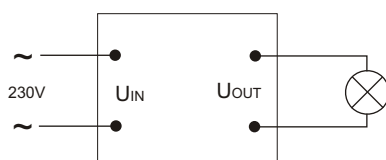

input Voltage	230V AC
output Voltage	230V AC
joint	1Z
current load	8A
rise time	1sec
power consumption of detection sensor	0,1W
working temperature	-25+50°C
connection	screw terminals 2,5mm <sup>2</sup>
dimensions	50×67×26mm
fixing	two screws to substrate

# 6. RADIO CONTROL RELAYS

## PURPOSE

Electronic relays are used for radio remote control of gates, shutters, lighting, arming alarm systems, etc. The remote control system consisting of a transmitter (remote) and receiver (relay). There is a possibility of cooperation between many transmitters to one receiver and one transmitter to multiple receivers.

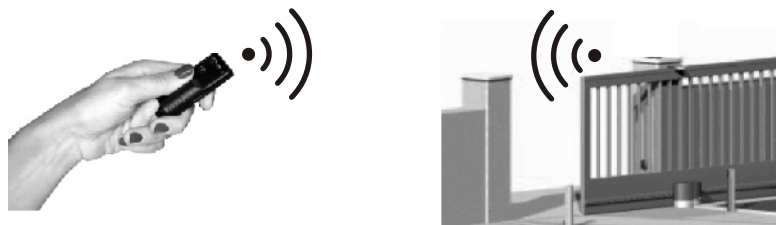

## FUNCTIONING

The impulse caused by the push of a button on the remote control to send a coded signal to the receiver. Remote control is protected against break transmission after releasing the button. Thanks to this, even the shortest activation function is the full frame of data transmissions. Data transmission from the remote control is indicated by flashing of red LED on the remote. The range of the system is up to 100m (Range depends on many factors, among others, on: the weather (humidity), terrain characteristics (reflection), placement of the receiver and transmitter, and all kinds of obstacles such as walls).

## RECEIVERS

Receivers are designed for under plaster box montage. In receiver's non-volatile memory can be store up to 32 transmitters. Radio receivers RS-407B i RS-407M cooperate with dedicated production units F & F: transmitter RS-N and RS-P.

### RS-407 M MONOSTABLE TYPE

The push transmitter's button will effect of closes the receiver's contact of X1-X2 at time 1 ~ 2 sec (pulse).

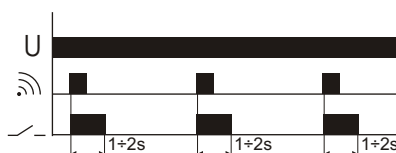

supply	230V AC
current load	<5A
joint	separate 1Z
signaling of recieving/programming	red LED
state of joint	green LED
power consumption	0,8W
connection	4×LY 1mm <sup>2</sup> ; l=10cm
working temperature	-25+50°C
dimensions	Ø55, h=13mm

### RS-407 B BISTABLE TYPE

The push transmitter's button will effect of closes the receiver's contactr on the opposite interface (ON/OFF).

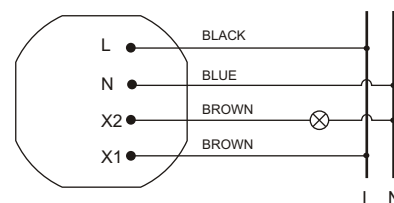
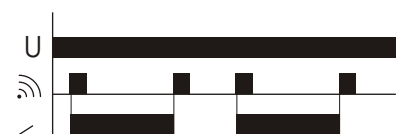

## TRANSMITTERS

The impulse caused by the push of a button on the remote control to send a coded signal to the receiver. Remote control is protected against break transmission after releasing the button. Thanks to this, even the shortest activation function is the full frame of data transmissions. Data transmission from the remote control is indicated by flashing of red LED on the remote.

Radio Transmitters cooperate with dedicated production units F & F: monostable receiver RS-407M monostable and bistable receiver RS-407B.

### RS-N... TO UNDER PLASTER BOX TRANSMITTER



The transmitter for installation in under plaster box. It has a stand-alone battery powered, which eliminates the need for a power cable at the mounting location of buttons. For the control we can use the monostable (instantaneous) buttons of any series wiring accessories.



type	no of channels
RS-N1	1
RS-N2	2
RS-N3	3
RS-N4	4

supply	3V
battery type	CR2032
transmission	dynamic, variable code
frequency	868Mhz
coding	Keelog®
working temperature	-25+50°C
connections	LGY 0,5mm <sup>2</sup>
dimensions	Ø52, h=11mm
fixing	to under plaster box Ø60

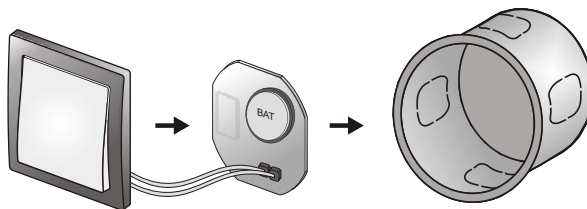

fixing to under plaster box

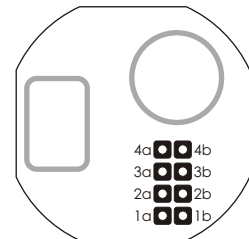

channels connections

### RS-P... REMOTE CONTROL

The small remote as a pendant.



type	no of button
RS-P1	one-button
RS-P2	two-button
RS-P3	three-button
RS-P4	four-button

supply	12V
battery type	A23
transmission	dynamic, variable code
frequency	868Mhz
coding	Keelog®
working temperature	-25+50°C
color	black
dimensions	30×68×14

# 7. INFRARED MOTION SENSOR SWITCH

## PURPOSE

Motion sensors are used for automatic attached temporary lighting in the event of a person or other object in such areas as hallways, courtyards, approach and access roads, garages, etc. The use of motion sensors to automatically accompany the lighting makes use of the lighting is more convenient and cheaper in operation.

## INFRARED

### FUNCTIONING

The sensor detects infrared radiation source. It's analysing parameters as the size of the object, the amount of heat emitted, and the speed of movement between the various sectors of detection. Detector head is moving in two dimensions, which allows for precise setting of the matched field detection to the individual requirements of the user. Movement detection in the box will automatically attach to the lighting time set by the user. After that time, the lighting is switched off automatically. Motion sensor is equipped with an automatic control include preventing crepuscular lighting during the day. The state detector and a willingness to attach lighting is activated only after dusk. The timing of activation of the sensor can be adjusted by the user potencjometrem.

**DR-05 W** WHITE

**DR-05 B** BLACK

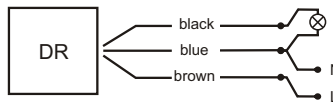

supply	230V AC
current load	<5A
ambient light	3÷2000Lx
detection motion speed	0,6÷1,5m/sek
time-delay	8sek±3sek + 10min±2min
detection range - horizontal	140°±180°
detection range - vertical	0°±45°
detection distance (for <24°C)	12m
instalation height	0,5÷3,5m
power consumption	0,45W
connection	screw terminals 1,5mm²
working temperature	-20÷40°C
dimensions	75×87×185mm
fixing	two screws to substrate
protection level	IP40

**DR-06 W** WHITE

**DR-06 B** BLACK

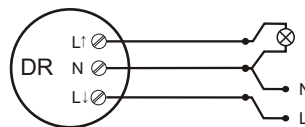
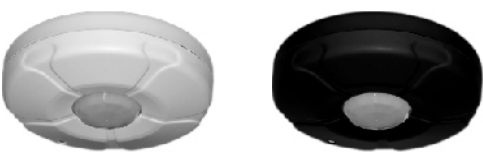

supply	230V AC
current load	<7A
ambient light	3÷2000Lx
detection motion speed	0,6÷1,5m/sek
time-delay	10sek±5sek + 4min±1min
detection range - horizontal	360°
detection distance (for h=3m, T<24°C)	r=5m
instalation height	h=2,5÷3m
power consumption	0,45W
connection	screw terminals 1,5mm²
working temperature	-20÷40°C
dimensions	Ø=110mm, h=35mm
fixing	two screws to substrate
protection level	IP20

## MICROWAVE

### PURPOSE

Microwave sensor allows for motion detection by wooden boards, plasterboard panels, glass and plastics.

### FUNCTIONING

DRM sensor emits and bounces high-frequency 5.8GHz electromagnetic waves. The sensor detects changes in the reflected waves caused by movement of the object in the area of detection. The sensor detects movement of an object to and from the sensor. Movement in the range of detection will automatically attach the lighting for time set by the user. After this time the lights will be turned off automatically. The motion sensor is equipped with Light dependant relay able to attaching lighting during the day. Detection status and stand-by to attach lights are activated only after dusk. Sensor activation time might be adjust by the user. In addition, there is a possibility of adjustment of the detection area in range and the receiver actuation time. The sensor allows for motion detection by wooden boards, plasterboard panels, glass and plastics. Temperature changes do not affect on motion detection.

The power of microwave radiation is relatively low and is completely safe for humans and animals. Its value is less than 10mW. By comparison, microwaves and cell phones radiate about 1000mW of power (100 times harder).

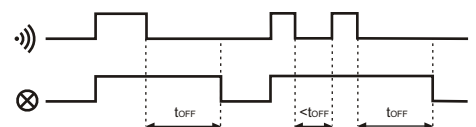

**DRM-01 BUILD-IN**

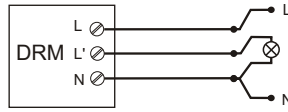

supply	230VAC
current load	<5A
frequency of the microwaves radiation	5,8GHz
power radiation	<10mW
detection range	360°
detection ray - adjustable (for h=2,5m)	1+10m
activation treshold - adjustable	2+2000Lx
receiver's activation time - adjustable	8sec+12min
activation delay	1sec
power consumption	0,9W
connection	screw terminals 1mm <sup>2</sup>
working temperature	-25+50°C
dimensions	46×93×42mm
fixed	two screws to the substrate
protection level	IP20

**DRM-02 CEILING**

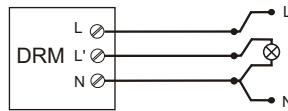

supply	230VAC
current load	<5A
frequency of the microwaves radiation	5,8GHz
power radiation	<10mW
detection range	360°
detection ray - adjustable (for h=2,5m)	1+10m
activation treshold - adjustable	2+2000Lx
receiver's activation time - adjustable	8sec+12min
activation delay	1sec
power consumption	0,9W
connection	screw terminals 1mm <sup>2</sup>
working temperature	-25+50°C
dimensions	∅103 h=42mm
fixed	two screws to the substrate
protection level	IP40

**DRM-03 PLAFOND WITH HIDDEN SENSOR**

**DRM-L PLAFON WITHOUT HIDDEN SENSOR**



supply	230VAC
type of light bulb	E27 max. 60W
frequency of the microwaves radiation	5,8GHz
power radiation	<10mW
detection range	360°
detection - adjustable	1+8m
activation treshold - adjustable	2+2000Lx
receiver's activation time - adjustable	5sec+15min
activation delay	1sec
power consumption of sensor	0,9W
connection	screw terminals 1,5mm <sup>2</sup>
working temperature	-25+50°C
dimensions	∅285 h=110mm
fixed	three screws to the substrate
lampshade	milk-white glass

**DRM-04 PLAFOND LED WITH MICROWAVE MOTION DETECTOR**



supply	230VAC 50Hz
light source	96xLED
light color	6000K
electric power of LED	15W
frequency of the microwaves radiation	5,8GHz
power radiation	<0,2mW
detection range	360°
detection ray-adjustable	2+10m
activation treshold-adjustable	2+2000Lx
receiver's activation time - adjustable	5sec+20min
activation delay	1sec
power consumption of detection sensor	0,9W
working temperature	-25+50°C
connection	6×LY 0,75mm, l=10cm
dimensions	∅295, h=100mm
fixing	4 screws to the substrate
shade	jointed, milk-white
protection level	IP54

# 8. ROLLER BLIND CONTROLLER

## PURPOSE

The roller blind controllers are designed for controlling roller blinds (up and down movement) or other devices (for example, gates) that are driven by a single-phase AC electric motor and operated by means of momentary switches (for example, bell-pushes). The controller can operate as an independent unit (designated for opening/closing one roller blind) as well as the controllers can be combined into groups that enable the central controlling of many roller blinds

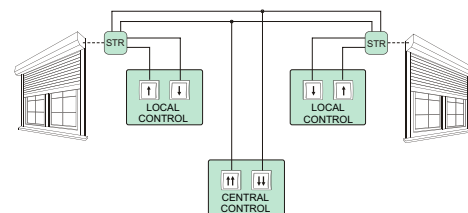

## FUNCTIONING

The roller blind motor is activated by the momentary switching of a current pulse (L or N) to one of the control inputs. The motor is activated at a time programmed previously by the user. The activation time programmed enables the complete lifting or lowering of the roller blind. Also, there is a possibility of stopping the rolled blind activated at a level selected by the user (non-complete opening or closing of the roller blind).

## DOUBLE-BUTTON TYPE

**Local control** - a group of push-buttons that controls one roller blind. ↑ - upwards (opening); ↓ - downwards (closing). Pressing the local control push-button activates the movement of the roller blind in a selected direction. If the roller blind is already moving, pressing the local control push-button will stop the roller blind.

**Central control** - a common group of push-buttons for many controllers (minimum two controllers) that controls all roller blinds included in the central control system. ↑↑ - all upwards; ↓↓ - all downwards. Pressing the central control push-button activates the movement of the roller blinds in a selected direction. If one of the roller blinds is already moving in the same direction, its movement will be continued. If one of the roller blinds is moving in the opposite direction, this roller blind will be first stopped and then its movement will be activated in the direction in accordance with the command sent to the central input. The central control enables only activating the movement of the roller blinds in a selected direction. The roller blind will be stopped after the programmed movement time or when any of the local control push-buttons is pressed.

## STR-1

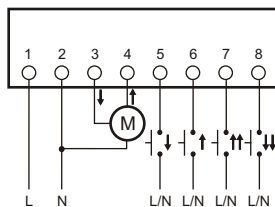

supply	230V AC
current load AC-3	<2A
control pulse current for L/N	<1mA
actuation time - programmable	0sec+10min
indication of power suppl/programming	LED green
power consumption	1W
working temperature	-25+50°C
connection	signal 4×DY 1mm <sup>2</sup> , l=10cm
	supplying 4×DY 1,5mm <sup>2</sup> , l=10cm
dimensions	Ø55, h=13mm
fixed	to under plaster box Ø60

## STR-21

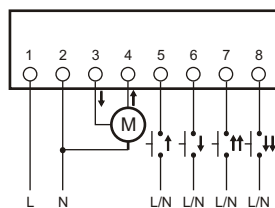
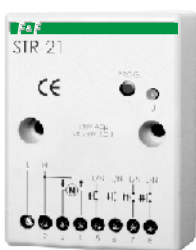

supply	STR-21 230V	230V AC
current load AC-3		<2A
control pulse current for L/N		<1mA
power supply indicator		LED green
power consumption		0,8W
working temperature		-25 +50°C
connection		screw terminals 2,5mm <sup>2</sup>
dimensions		50×67×26mm
fixing		two screws to the base

## STR-421

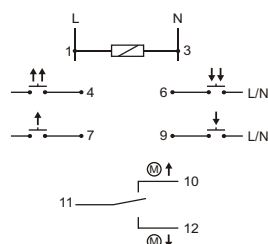

supply	STR-421 230V	230V AC
	STR-421 24V	24V AC
current load AC-3		<2A
control pulse current for L/N		<1mA
power supply indicator		LED green
operating mode indicator		2×LED red
power consumption		0,8W
working temperature		-25 +50°C
connection		screw terminals 2,5mm <sup>2</sup>
dimensions		1 module (18mm)
fixing		on rail TH-35

## ONE-BUTTONS

**Local control** - a group of push-buttons that controls one roller blind. ↑↓-upwards (opening) / downwards (closing). Pressing the local control push-button activates the movement of the roller blind in a direction opposite to the direction of a previously performed movement (after connecting the controller to the power supply, the first movement closes the roller blind). If the roller blind is already moving, pressing the local control push-button will stop the roller blind movement. When the local control push-button is pressed again, the movement of the roller blind in the opposite direction is activated.

**Central control** - a common group of push-buttons for many controllers (minimum two controllers) that controls all roller blinds included in the central control system. ↑↑ - all upwards; ↓↓ - all downwards. Pressing the central control push-button activates the movement of the roller blinds in a selected direction. If one of the roller blinds is already moving in the same direction, its movement will be continued. If one of the roller blinds is moving in the opposite direction, this roller blind will be first stopped and then its movement will be activated in the direction in accordance with the command sent to the central input. The central control enables only activating the movement of the roller blinds in a selected direction. The roller blind will be stopped after the programmed movement time or when any of the local control push-buttons is pressed.

### STR-2

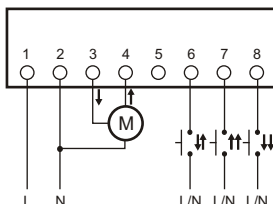

supply	230V AC
current load AC-3	<2A
control pulse current for L/N	<1mA
actuation time - programmable	0sec+10min
indication of power suppl/programming	LED green
power consumption	1W
working temperature	-25+50°C
connection	signal 4×DY 1mm <sup>2</sup> , l=10cm
	supplying 4×DY 1,5mm <sup>2</sup> , l=10cm
dimensions	Ø55, h=13mm
fixed	to under plaster box Ø60

### STR-22

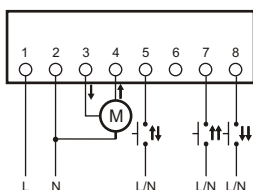

supply	STR-22 230V	230V AC
current load AC-3		<2A
control pulse current for L/N		<1mA
power supply indicator		LED green
power consumption		0,8W
working temperature		-25 +50°C
connection		screw terminals 2,5mm <sup>2</sup>
dimensions		50×67×26mm
fixing		two screws to the base

### STR-422

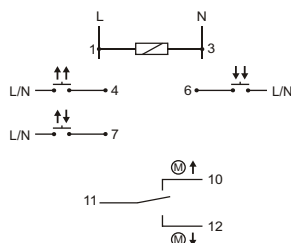

supply	STR-422 230V	230V AC
	STR-422 24V	24V AC
current load AC-3		<2A
control pulse current for L/N		<1mA
power supply indicator		LED green
operating mode indicator		2×LED red
power consumption		0,8W
working temperature		-25 +50°C
connection		screw terminals 2,5mm <sup>2</sup>
dimensions		1 module (18mm)
fixing		on rail TH-35

#### PRACTICAL SOLUTIONS

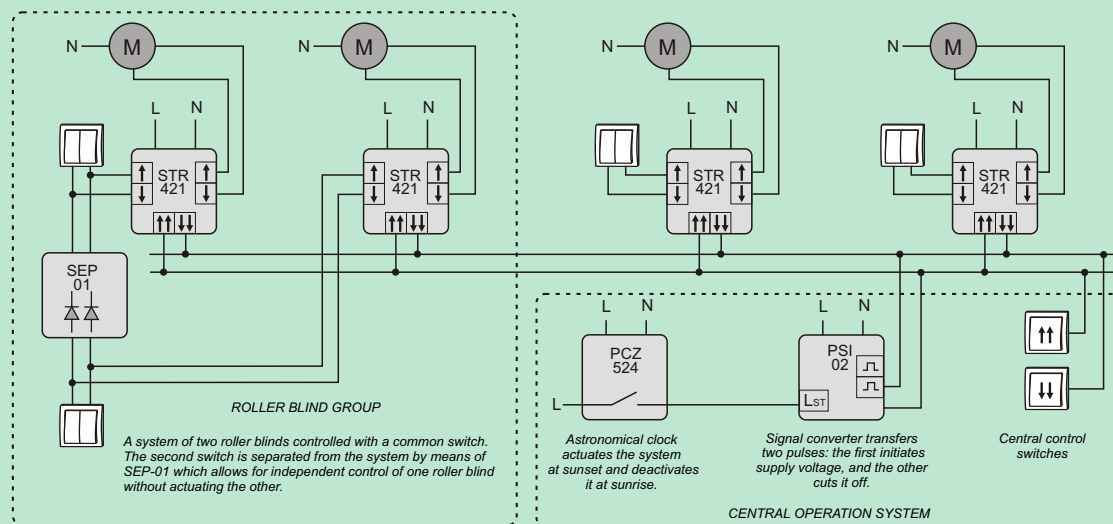

# 9.

# PHASE CONTROL RELAYS

## 9.1 THREE-PHASE MONITORS

### PURPOSE

Three phase monitors serve to protect the three-phase electric motors supplied from three-phase mains, against phase collapse in at least one phase or against phase-to-phase voltage asymmetry, threatening to damage the motor.

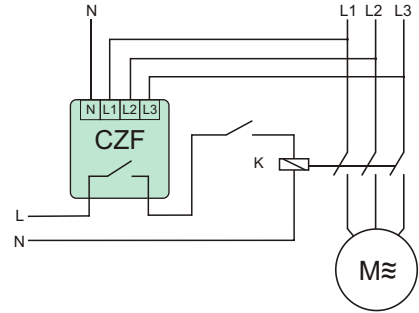

### WITH FIXED ACTUATION THRESHHOLD VOLTAGE ASYMMETRY

#### FUNCTIONING

Phase collapse in at least one phase or voltage unbalance between phases above fixed actuation threshold causes switching-OFF the motor. The motor switching-OFF occurs with delay, which prevents any accidental motor disconnecting at temporary voltage drop. The re-connection will occur automatically at voltage increase of 5V above activation voltage (i.e. of value of voltage hysteresis). At occurrence of these disturbances, it is not possible to set a motor in motion.

### CZF

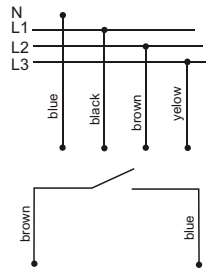

supply	3x400/230V+N
contact	1N/O
current load	<10A
sygnalling of supply	LED in each phase circuit
activation voltage asymmetry	45V ~
hysteresis	5V~
switching-OFF delay	4sec
power consumption	1,6W
connection	4x1mm <sup>2</sup> , 2x0,75mm <sup>2</sup> ; I=0,5m
durability	10 <sup>5</sup> of switching
working temperature	-25+40°C
dimensions	50x67x26 mm
fixing	two screws to the base

### CZF-B

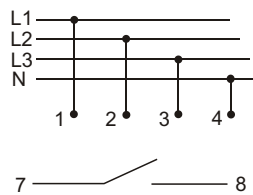

supply	3x400/230V+N
contact	1N/O
current load	<10A
sygnalling of supply	LED in each phase circuit
activation voltage asymmetry	45V ~
hysteresis	5V~
switching-OFF delay	4sec
power consumption	1,6W
connection	screw terminals 2,5mm <sup>2</sup>
durability	10 <sup>5</sup> of switching
working temperature	-25+50°C
dimensions	2 modules (35mm)
fixing	on rail TH-35

### CZF-BS

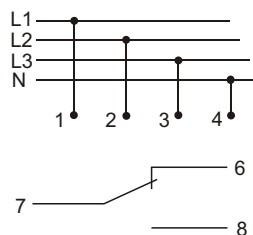

supply	3x400/230V+N
contact	1C/O
current load	<10A
sygnalling of supply	LED in each phase circuit
activation voltage asymmetry	45V ~
hysteresis	5V~
switching-OFF delay	4sec
power consumption	1,6W
connection	screw terminals 2,5mm <sup>2</sup>
durability	10 <sup>5</sup> of switching
working temperature	-25+40°C
dimensions	2 modules (35mm)
fixing	on rail TH-35



## CZF-310

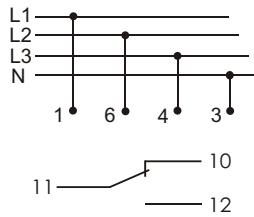

supply	3x400/230V+N
contact	1C/O
current load	<10A
sygnalling of supplay	LED in each phase circuit
activation voltage asymmetry	45V~
activation voltage	185V~
histeresis	5V~
switching-OFF delay	4sec
power consumption	0,56W
connection	screw terminals 2,5mm <sup>2</sup>
durability	10 <sup>5</sup> of switching
working temperature	-25+40°C
dimensions	1 module (18mm)
fixing	on all TH-35

## AND ADJUSTABLE ACTUATION THRESHHOLD AT VOLTAGE ASYMMETRY

### FUNCTIONING

Phase collapse in at least one phase or voltage unbalance between phases above set value causes switching-OFF the motor. The motor switching-OFF occurs with 4 sec delay, which prevents any accidental motor disconnecting at temporary voltage drop. The re-connection will occur automatically at voltage increase of 5V above activation voltage (i.e. of value of voltage hysteresis). At occurrence of these disturbances, it is not possible to set a motor in motion.

## CZF-BR

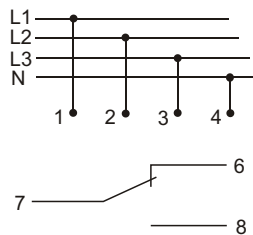

supply	3x400/230V+N
contact	1C/O
current load	<10A
sygnalling of supplay	LED in each phase circuit
activation voltage asymmetry	40+80V~
histeresis	5V~
switching-OFF delay	4sec
power consumption	1,6W
connection	screw terminals 2,5mm <sup>2</sup>
durability	10 <sup>5</sup> of switching
working temperature	-25+50°C
dimensions	2 modules (35mm)
fixing	on rail TH-35

## CZF-311

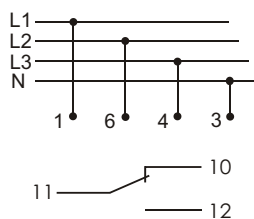

supply	3x400/230V+N
contact	1C/O
current load	<10A
sygnalling of supplay	LED in each phase circuit
activation voltage asymmetry	40+80V~
activation voltage	175+190V~
histeresis	5V~
switching-OFF delay	4sec
power consumption	1,6W
connection	screw terminals 2,5mm <sup>2</sup>
durability	10 <sup>5</sup> of switching
working temperature	-25+40°C
dimensions	1 module (18mm)
fixing	on rail TH-35

## CZF-BT WITH ADJUSTABLE ACTUATION TIME 0,5÷15sek

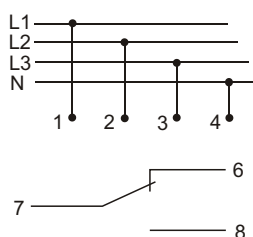

supply	3x400/230V+N
contact	1C/O
current load	<10A
sygnalling of supplay	LED in each phase circuit
activation voltage asymmetry	40+80V~
histeresis	5V~
switching-OFF delay	0,5+15sec
power consumption	1,6W
connection	screw terminals 2,5mm <sup>2</sup>
durability	10 <sup>5</sup> of switching
working temperature	-25+50°C
dimensions	2 modules (35mm)
fixing	on rail TH-35

**CZF-312 MONITOR WITHOUT ACTION DELAY 0,3SEC.**

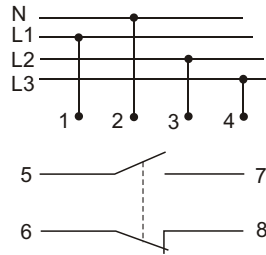

supply	3x400/230V+N
contact	1N/O, 1N/C
current load	2x(<5A)
sygnalling of supply	LED in each phase circuit
activation voltage asymmetry	40+55V~
activation voltage	175+190V~
hysteresis	5V~
switching-OFF delay	0,2sec
power consumption	1,2W
connection	screw terminals 2,5mm <sup>2</sup>
durability	10 <sup>5</sup> of switching
working temperature	-25+40°C
dimensions	1 module (18mm)
fixing	on rail TH-35

**CZF-331 WITH TWO SEPARATED CONTACTS 2C/O.**

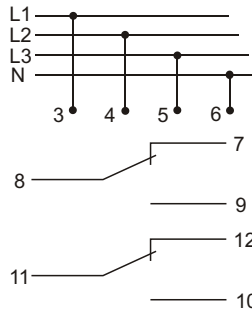

supply	3x230/400V+N
contact	2C/O
current load	2x(<8A)
sygnalling of supply	LED in each phase circuit
activation voltage asymmetry	40+80V~
hysteresis	5V~
switching-OFF delay	4sec
power consumption	1,2W
connection	screw terminals 2,5mm <sup>2</sup>
durability	10 <sup>5</sup> of switching
working temperature	-25+40°C
dimensions	3 modules (52,5mm)
fixing	on rail TH-35

**CZF-333**

**WITHOUT NEUTRAL LEAD.  
PREVENTS AGAINST SYMMETRICAL AND ASYMETRICAL VOLTAGE DROP.**

*In case the voltage asymmetry above set value between phases causes the switching-OFF the motor. The switching-OFF the motor also occurs in case of phase-to-phase voltage drop below 320V. The motor switching-OFF occurs with 4 sec delay, which prevents any accidental motor disconnecting at temporary voltage drop. The re-connection will occur automatically at voltage increase of 5V above activation voltage (i.e. of value of voltage hysteresis). At occurrence of these disturbances, it is not possible to set a motor in motion.*

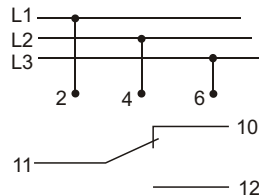

supply	3x400V
contact	1C/O
current load	<10A
sygnalling of supply	3xLED
activation voltage asymmetry	20+50V~
activation voltage	<320V~
hysteresis	5V~
switching-OFF delay	4sec
power consumption	1,6W
connection	screw terminals 2,5mm <sup>2</sup>
durability	10 <sup>5</sup> of switching
working temperature	-25+40°C
dimensions	3 modules (52,5mm)
fixing	on rail TH-35

**PRACTICAL SOLUTIONS**

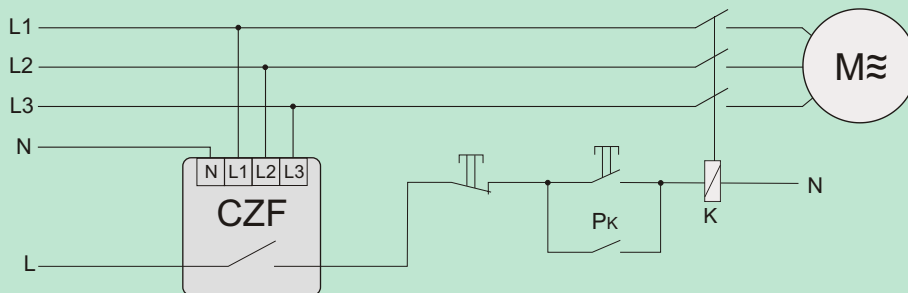

Example of

Connection example of control that prevents automatic return of the power of the motor.

# 9.2 THREE-PHASE MONITORS WITH CHECKING STATE OF CONTACTOR CONTACTS

## PURPOSE

Three phase monitor serves to protect the three-phase electric motors supplied from three-phase mains, against phase collapse in at least one phase or against phase-to-phase voltage asymmetry or against damage of contacts threatening to damage the motor.

## FUNCTIONING

Phase collapse in at least one, optional phase or voltage unbalance between phase fixed actuation threshold causes switching-OFF the motor. The motor switching-OFF occurs with 4 sec delay, which prevents any accidental motor disconnecting at temporary voltage drop. The re-connection will occur automatically at voltage increase of 5V above activation voltage (i.e. of value of voltage hysteresis). At occurrence of these disturbances, it is not possible to set a motor in motion. Shining of red diode LED along with simultaneous disconnecting the apparatus permanently, indicates contactor contacts damage. Reactivation of the apparatus is possible (after contact repair), after disconnecting from supply all three phases (fuses) and then, after switching-ON anew.

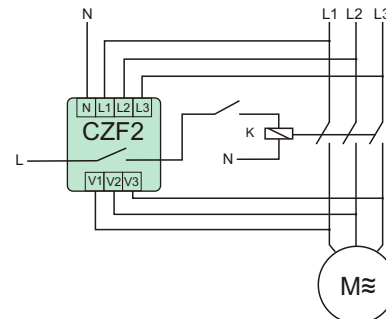

## CZF2

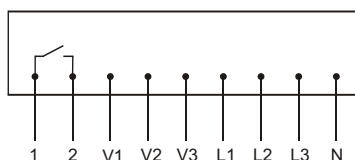

supply	3x400/230V+N
contact	1N/O
current load	<10A
sygnalling of supply	2xLED
activation voltage asymmetry	45V ~
activation voltage	185V~
hysteresis	5V~
switching-OFF delay	4sec
power consumption	1,6W
connection	screw terminals 2,5mm <sup>2</sup>
durability	10 <sup>5</sup> of switching
working temperature	-25+40°C
dimensions	95x60x25 mm
fixing	two screws to the base

## CZF2-B CONTACT CONNECTED TO POWER SUPPLY VOLTAGE.

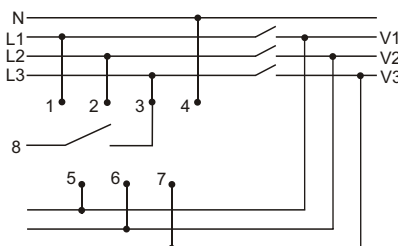

supply	3x400/230V+N
contact	1N/O
current load	<10A
sygnalling of supply	2xLED
activation voltage asymmetry	55V ~
hysteresis	5V~
switching-OFF delay	4sec
power consumption	1,6W
connection	screw terminals 2,5mm <sup>2</sup>
durability	10 <sup>5</sup> of switching
working temperature	-25+50°C
dimensions	2 modules (35mm)
fixing	on rail TH-35

## CZF2-BR CONTACT CONNECTED TO POWER SUPPLY VOLTAGE.

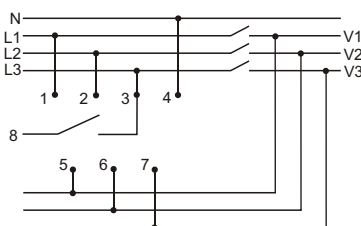

supply	3x400/230V+N
contact	1N/O
current load	<10A
sygnalling of supply	2xLED
activation voltage asymmetry	40+55V~
hysteresis	5V~
switching-OFF delay	4sec
power consumption	1,6W
connection	screw terminals 2,5mm <sup>2</sup>
durability	10 <sup>5</sup> of switching
working temperature	-25+40°C
dimensions	2 modules (35mm)
fixing	on rail TH-35

## CZF-332 WITH SEPARATED CONTACT.

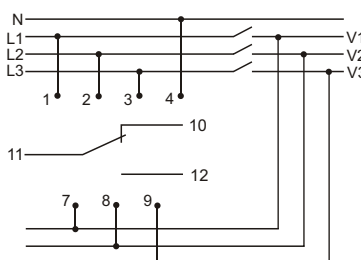

supply	3x400/230V+N
contact	1C/O
current load	<10A
sygnalling of supply	2xLED
activation voltage asymmetry	40+80V~
hysteresis	5V~
switching-OFF delay	3+5sec
power consumption	1,6W
connection	screw terminals 2,5mm <sup>2</sup>
durability	10 <sup>5</sup> of switching
working temperature	-25+40°C
dimensions	3 modules (52,5mm)
fixing	on rail TH-35

# 9.3 THREE-PHASE ASYMMETRY AND SEQUENCE MONITORS

## PURPOSE

Three phase and sequence monitor is designed to protect three phase electric motors against voltage drop in at least one phase or voltage asymmetry between phases, which could damage the motor, with additional protection of motor rotation direction in case of phase change before the monitor.

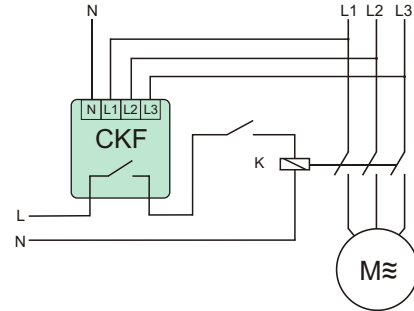

## WITH FIXED ACTUATION THRESHHOLD VOLTAGE ASYMMETRY

### FUNCTIONING

Voltage collapse in any phase or voltage asymmetry between phases above fixed actuation threshold causes switching-OFF the motor. The motor switching-OFF occurs after delay of 4 sec, which prevents accidental motor switching-OFF caused by instantaneous voltage drop. Switching the motor ON anew occurs automatically when the voltage increases of 5V~ above activation voltage (i.e. about value of voltage hysteresis). At occurrence of these disturbances, it is not possible to set motor in motion. In case of change of phase sequence, before the monitor, which causes change of motor rotation direction (in relation to that primarily set) is signaled by shining red diode LED along with impossibility of switching-on the motor. The re-connection is possible after the return to correct phase sequence.

### CKF

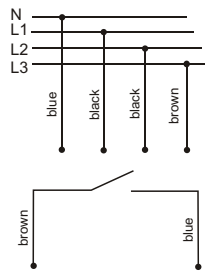

supply	3x400/230V+N
current load	<10A
signalling of supply	2xLED
activation voltage asymmetry	45V ~
hysteresis	5V~
switching-OFF delay	4sec
power consumption	1,6W
connection	4x1mm <sup>2</sup> , 2x0,75mm <sup>2</sup> ; l=0,5m
durability	10 <sup>5</sup> of switching
working temperature	-25+40°C
dimensions	50x67x26 mm
fixing	two screws to the base

### CKF-B

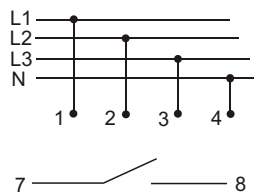

supply	3x400/230V+N
current load	<10A
signalling of supply	2xLED
activation voltage asymmetry	55V ~
hysteresis	5V~
switching-OFF delay	4sec
power consumption	1,6W
connection	screw terminals 2,5mm <sup>2</sup>
durability	10 <sup>5</sup> of switching
working temperature	-25+50°C
dimensions	2 modules (35mm)
fixing	on rail TH-35

### CKF-316

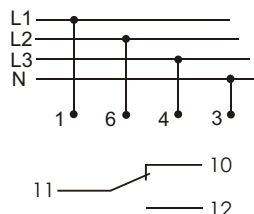

supply	3x400/230V+N
current load	<10A
signalling of supply	2xLED
activation voltage asymmetry	55V ~
hysteresis	5V~
switching-OFF delay	4sec
power consumption	1,6W
connection	screw terminals 2,5mm <sup>2</sup>
durability	10 <sup>5</sup> of switching
working temperature	-25+40°C
dimensions	1 module (18mm)
fixing	on rail TH-35

# AND ADJUSTABLE ACTUATION THRESHHOLD VOLTAGE ASYMMETRY

## FUNCTIONING

Voltage collapse in any phase or voltage asymmetry between phases above set value causes switching-OFF the motor. The motor switching-OFF occurs after delay of 4 sec, which prevents accidental motor switching-OFF caused by instantaneous voltage drop. Switching the motor ON anew occurs automatically when the voltage increases about 5V~ above activation voltage. At occurrence of these disturbances, it is not possible to set a motor in motion. In case of change of phase sequence, before the monitor, which causes change of motor rotation direction ( in relation to that primarily set) along with impossibility of switching-ON the motor. The rswitching-ON is possible after the return to correct phase sequence.

### CKF-BR

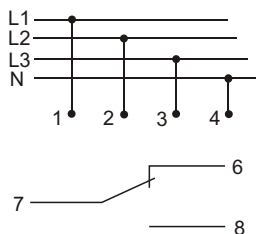

supply	3x400/230V+N
current load	<10A
contact	1 C/O
sygnalling of supplay	2xLED
activation voltage asymmetry	40+80V~
hysteresis	5V~
switching-OFF delay	4sec
power consumption	1,6W
connection	terminal screws 2,5mm <sup>2</sup>
durability	10 <sup>5</sup> of switching
working temperature	-25+50°C
dimensions	2 modules (35mm)
fixing	on rail TH-35

### CKF-317

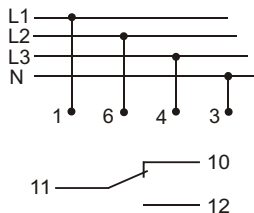

supply	3x400/230V+N
current load	<10A
contact	1 C/O
sygnalling of supplay	2xLED
activation voltage asymmetry	40+80V~
hysteresis	5V~
switching-OFF delay	4sec
power consumption	0,56W
connection	terminal screws 2,5mm <sup>2</sup>
durability	10 <sup>5</sup> of switching
working temperature	-25+40°C
dimensions	1 module (18mm)
fixing	on rail TH-35

### CKF-BT

WITH ADJUSTABLE ACTUATION TIME 0,5÷15sek

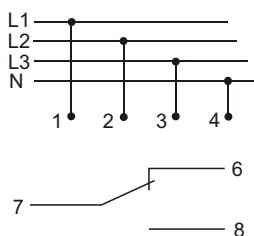

supply	3x400/230V+N
contact	1C/O
current load	<10A
sygnalling of supplay	LED in each phase circuit
activation voltage asymmetry	40+80V~
hysteresis	5V~
switching-OFF delay	0,5÷15sec
power consumption	1,6W
connection	screw terminals 2,5mm <sup>2</sup>
durability	10 <sup>5</sup> of switching
working temperature	-25+50°C
dimensions	2 modules (35mm)
fixing	on rail TH-35

### CKF-337

WITHOUT NEUTRAL LEAD.  
PREVENTS AGAINST SYMMETRICAL AND ASYMETRICAL VOLTAGE DROP.

In case of voltage asymmetry above set value between phases causes the switching-OFF the motor. The switching-OFF the motor also occurs in case of phase-to-phase voltage drop below 320V. The motor switching-OFF occurs with 4 sec delay, which prevents any accidental motor disconnecting at temporary voltage drop. The re-connection will occur automatically at voltage increase of 5V above activation voltage (i.e. of value of voltage hysteresis). At occurrence of these disturbances, it is not possible to put a motor to motion.

Change of phase sequence, before the monitor, which causes change of motor rotation direction ( in relation to that primarily set) along with impossibility of switching-ON the motor.

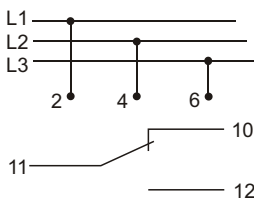

supply	3x400V
contact	1 C/O
current load	<10A
sygnalling of supplay	4xLED
activation voltage asymmetry	20+50V~
activation voltage	<320V~
hysteresis	5V~
switching-OFF delay	4sec
power consumption	1,6W
connection	terminal screws 2,5mm <sup>2</sup>
durability	10 <sup>5</sup> of switching
working temperature	-25+40°C
dimensions	3 modules (52,5mm)
fixing	on rail TH-35

# 10. VOLTAGE RELAYS

**PURPOSE**

Voltage relays serve to voltage control in single or three phase mains and to protect receiver against the effects of voltage collapse or increase beyond set values.

**ATTENTION!**

All types of CP can be supplied with a voltage up to 450V~. This ensures the effective protection of the receiver even in case of a voltage increase beyond allowable standards. Also, in case of supply polarity exchange or when "zero" is switched off (for three-phase types) the relay will not be destroyed ("burned").

**FUNCTIONING**

Lower voltage value (U1) and upper voltage value (U2) are set by means of potentiometers. It is so-called eye of voltage, in limits of which can occur changes of phases voltages that do not cause activation of relay. Change of phase voltage on one of phases above or below set voltage thresholds will cause activation of relay. Reactivation follows automatically return of correct voltage value.

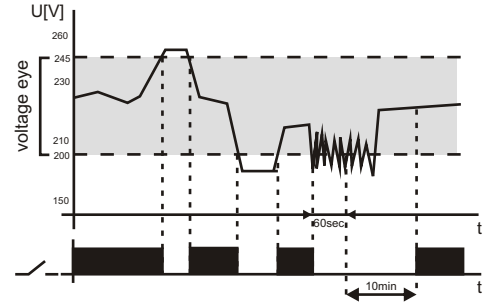
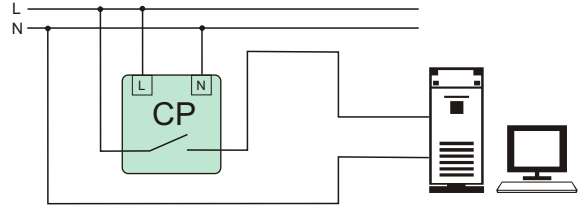

**ONE-PHASE TYPE**

**CP-709 WITHOUT TIME-BLOCKADE**

**CP-710 WITH TIME-BLOCKADE**

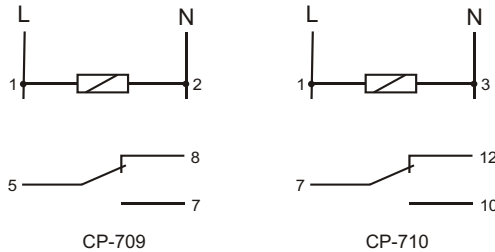

Supply	50+450V AC
current load	<16A
Contacts	1 C/O
signalling of supply	4xLED
<b>Voltage Value</b>	
lower U1	150+210V
upper U2	230+260V
<b>hysteresis</b>	
for U1	5V
for U2	5V
<b>activation lag delay functions</b>	
for U1	1,5sec
For U2	0,1sec
<b>Recovery time</b>	
for U1	1,5sec
for U2	1,5sec
power consumption	0,8W
Connection	screw terminals 2,5mm <sup>2</sup>
working temperature	-25+50°C
Dimension	1 module (18mm)
fixing	on rail TH-35

**CP-710:** Because of unstable voltage in mains and frequent changes of supply voltage beyond the set thresholds of "eye of voltage" (at least 10 times per 1minute), relay blocks itself for 10 minutes. This prevents against too frequent, cyclic switching-ON and OFF of the connected receiver.

**CP-721 PROGRAMMABLE**

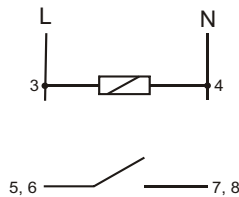

supply	150+450V AC
current load AC1	2x<8A
joint	separate 1P (1CO)
<b>voltage activation threshold / skip</b>	
down UL	150+210V / 1V
up UH	230+260V / 1V
<b>hysteresis voltage return to UL/UH</b>	
activation time / skip	5V
to threshold UL	2+10sec / 1sec
to threshold UH	0,1+1sec / 0,1sec
return time to UL/UH	2sec+9,5min
setting precision	1V
measure precision	±1V
display	3xsegment LED 5x9mm
indication of contact closure	LED red
power consumption	0,8W
connections	screw terminals 2,5mm <sup>2</sup>
working temperature	-25+50°C
dimensions	2 modules (35mm)
fixing	on the rail TH-35

**FUNCTIONS:**

- setting voltage window (thresholds U1 and U2)
- separate setting response times for exceeding the limits U1 and U2
- setting the time to return
- continuous indication of the voltage
- indication of the correct voltage and contact closure

## THREE-PHASES TYPE

### CP-730 WITH TIME-BLOCKADE

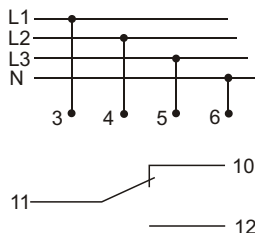

Because of unstable voltage in mains and frequent changes of supply voltage beyond the set thresholds of “eye of voltage” (at least 10 times per 1minute), relay blocks itself for 10 minutes. This prevents against too frequent, cyclic switching-ON and OFF of the connected receiver.

Supply	3×(50÷450V)+N
current load	<10A
Contacts	1 C/O
sygnalling of supplay	4×LED
Voltage Value	
lower U1	150÷210V
upper U2	230÷260V
hysteresis	
for U1	5V
for U2	5V
activation lag delay functions	
1,5sec for U1 - adjustable	0,5÷10sec
For U2	0,1sec
Recovery time	
for U1	1,5sec
for U2	1,5sec
power consumption	0,8W
Connection	screw terminals 2,5mm <sup>2</sup>
working temperature	-25÷50°C
Dimension	3 modules (52,5mm)
fixing	on rail TH-35

## UNDER VOLTAGE

### CP-733 Contatas 3×1N/C

### CP-734 Contacts 3×1N/O

**CP-733:** A voltage relay is used to control voltage in a 3-phase network and secure a receiver against voltage drops below a preset value. Voltage decay in a phase or its drop below a preset activation threshold results in the shortage of the relay contact for this phase. The contact will be automatically released after the voltage in the phase is reinstated or its increase is 5V over the preset threshold (i.e. the voltage hysteresis value).

**CP-734:** A voltage relay is used to control voltage in a 3-phase network and secure a receiver against voltage drops below a preset value. Voltage decay in a phase or its drop below a preset activation threshold results in the opened of the relay contact for this phase. The contact will be automatically released after the voltage in the phase is reinstated or its increase is 5V over the preset threshold (i.e. the voltage hysteresis value).

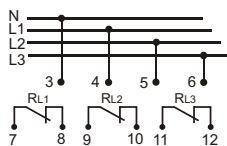

CP-733

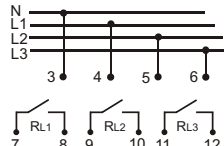

CP-734

Supply	3×(50÷4 50V)+N
Current load	3×(<8A)
contact CP-733	separated 3×1NC
3×1NO CP-734	separated
sygnalling of supply	3×LED
Switching delay	170÷210V
Histeresis	5V
operation time	0,5sek
Power supply return	1,5sek
Power consumption	0,8W
terminal	screw terminals 2,5mm <sup>2</sup>
Working temperature	-25÷50°C
durability	10 <sup>5</sup> of switching
Dimensions	3 modules (52,5mm)

## CP-500 POWER SUPPLY 3×500V. WITHOUT NEUTRAL

### PROTECTING FEATURES

- PROTECTION AGAINST PHASE COLLAPSE
- PROTECTION AGAINST OF PHASE CHANGE ORDER
- PROTECTION AGAINST PHASE ASYMMETRY
- PROTECTION AGAINST CROSSING OVER VOLTAGE 580V
- PROTECTION AGAINST DECLINE BELOW VOLTAGE 420V

### FUNCTIONING

With the correct network voltage contacts remain closed. Operation of any security opens the sensor's contacts. Closure of the contacts will automatically after return the correct network parameters.

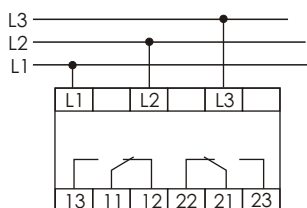

supply	3×500V
current load	2×[<8A]
contact	separated 2P
status indication	6×LED
activation asymmetry - adjustable	5÷80V
activation time- radjustable	1÷10sec
time to return	1,5sec
threshold voltage activation	
upper	580V
lower	420V
return voltage hysteresis	5V
power consumption	0,7W
protection level	IP20
connection	screw terminals 2,5mm <sup>2</sup>
working temperature	-25÷50°C
dimensions	4 modules (70mm)
weigh	250g
fixing	on rail TH-35

# 11. AUTOMATIC PHASE SWITCHES

## PURPOSE

Automatic phase switches serve to maintain continuity of power supply to single-phase receivers in the event of power phase decay or a drop in its parameters below standard values.

They exemplify one-phase automatic switching system. They are especially suitable where is required the continuity of correct power supply parameters, for example, refrigeration, airconditioning, computer networks and telecommunications, cable television, alarm systems, etc.

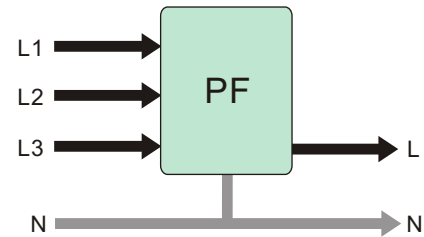

## PF-431 WITH "PRIORITY" PHASE

### FUNCTIONING

Three-phase voltage (3x230V+N) is supplied to the input of the switch. Single-phase voltage (230V AC), i.e. the phase voltage of one of the phases, is supplied to the output of the switch. The electronic system of the switch controls voltage values of the phases supplied in such a way as to ensure that output voltage is not lower than 195V. The phase that has correct parameters is directed to the output of the switch. The L1 phase is the priority phase, i.e. if its parameters are correct, this phase will be always switched to the output. If the voltage parameters of the L1 phase are not correct or if voltage decay occurs in this phase, the electronic system will switch the L2 phase to the output (provided that its parameters are correct). In case of a simultaneous lack of correct voltages in the L1 and L2 phases, the L3 phase will be switched to the output. When the correct supply voltage returns to the L1 phase, the electronic system will switch this phase to the output.

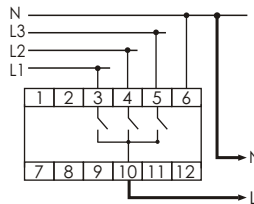

supply	3x400+N
output	230V AC
current load	<16A
activation threshold	
for L1 and L2 (lower / upper)	<195V / >250V
for L3 (lower / upper)	<190V / >250V
hysteresis	5V
working temperature	-25+50°C
switching time	0,5+0,8sec
power supply indicator	3x green LED
connection	terminal screws 2,5mm <sup>2</sup>
dimensions	3 modules (52,5mm)
terminal	on rail TH-35

## PF-441 WITH "PRIORITY" PHASE. FOR CO-OPERATING WITH CONTACTORS

### FUNCTIONING

The directly connected switch is used for supplying the single-phase circuit whose current-load does not exceed 16A. For the circuits that have a current-load higher than 16A, a configuration is used that consists of a switch and three contactors that have a properly selected current-carrying capacity. Three-phase voltage (3x230V+N) is supplied to the input of the switch (L1, L2, L3, N). Single-phase voltage (230V AC), i.e. the phase voltage of one of the phases, is directed to the output of the switch (T1, T2, T3). The electronic system of the switch controls voltage values of the phases supplied. The phase that has correct parameters is switched to the output of the switch. The L1 phase is the priority phase, i.e. if its parameters are correct, this phase will be always switched to the output. If the voltage parameters of the L1 phase are not correct or if voltage decay occurs in this phase, the electronic system will switch the L2 phase to the output (provided that its parameters are correct). In case of a simultaneous lack of correct voltages in the L1 and L2 phases, the L3 phase will be switched to the output. When the correct supply voltage returns to the L1 phase, the electronic system will switch this phase to the output. The switch-over time (required for voltage to occur at the output) after the decay of a currently activated phase is from 0.5 to 0.8 sec. (during this time the receivers are not supplied). Uk input is used for controlling the voltages activated. The system enables the activation of only one phase. In this way the simultaneous switching of voltages of two phases to the output is prevented. Such simultaneous switching of voltages might lead to a phase-to-phase fault. Also, the defect of the contactor (for example, a break in the coil circuit, suspending or burning out of the working contactor) will cause the switching of the receiver to another phase despite the fact that the voltage in a given phase is correct. If the contacts of the contactor are permanently closed, the system will not switch to another contactor despite the fact that the voltage in this phase is incorrect. After the activation of supply voltage (at least one phase), the system examines the correctness of voltages supplied for 2 seconds and only after that time the system switches the phase to the output.

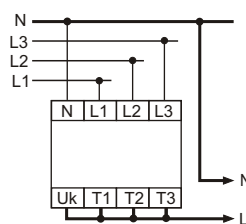

without contactors

supply	3x400+N
output	230V AC
current load	
without contactors	<16A
with contactors up to max. capacity of the contacts	
activation threshold	
lower	<195V
upper	>250V
hysteresis	5V
working temperature	-25+50°C
switching time	0,5+0,8sec
power supply indicator	green LED
signalization of phase selection	3 x yellow LED
connection	
for L1, L2, L3, N pin	terminal screws 2,5mm <sup>2</sup>
for T1, T2, T3, Uk pin	terminal screws 1,5mm <sup>2</sup>
dimensions	4 modules (70mm)
fixing	on rail TH-35



System with connectors is applied with receiver current exceeding 16A.

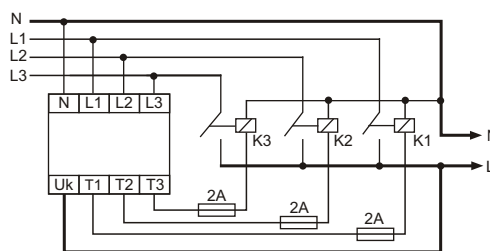

with contactors

## PF-451 WITH "PRIORITY" PHASE

FOR CO-OPERATING WITH CONTACTORS.

WITH ADJUSTABLE LOWER (170÷210V) AND UPPER (230÷260V) ACTUATION THRESHOLD

### FUNCTIONING

The directly connected switch is used for supplying the single-phase circuit whose current-load does not exceed 16A. For the circuits that have a current-load higher than 16A, a configuration is used that consists of a switch and three contactors that have a properly selected current-carrying capacity. Three-phase voltage (3x230V+N) is supplied to the input of the switch (L1, L2, L3, N). Single-phase voltage (230V AC), i.e. the phase voltage of one of the phases, is directed to the output of the switch (T1, T2, T3). The electronic system of the switch controls voltage values of the phases supplied. The phase that has correct parameters is switched to the output of the switch. Phase switching sequence is not specified the phase that has the best parameters is always switched to the output. Switching to another phase that has correct parameters occurs only after a drop in values of parameters of the currently used phase. The switch-over time (required for voltage to occur at the output) after the decay of a currently activated phase is from 0.5 to 0.8 sec. (during this time the receivers are not supplied). Uk input is used for controlling the voltages activated. The system enables the activation of only one phase. In this way the simultaneous switching of voltages of two phases to the output is prevented. Such simultaneous switching of voltages might lead to a phase-to-phase fault. Also, the defect of the contactor (for example, a break in the coil circuit, suspending or burning out of the working contactor) will cause the switching of the receiver to another phase despite the fact that the voltage in a given phase is correct. If the contacts of the contactor are permanently closed, the system will not switch to another contactor despite the fact that the voltage in this phase is incorrect. After the activation of supply voltage (at least one phase), the system examines the correctness of voltages supplied for 2 seconds and only after that time the system switches the phase to the output. The switch provides the option of adjusting a lower voltage threshold (150V to 210V) and an upper voltage threshold (230V to 260V) at which switching-over occurs.

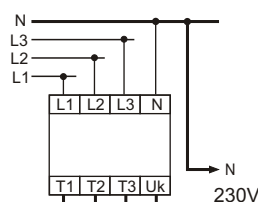

without contactors

supply	3x400+N
output	230V AC
current load	
without contactors	<16A
with contactors	up to max. capacity of the contacts
activation threshold	
lower	170÷210V
upper	230÷260V
hysteresis	5V
working temperature	-25÷50°C
switching time	0,5±0,8sec
power supply indicator	green LED
signalization of phase selection	3 x yellow LED
connection	terminal screws 2,5mm <sup>2</sup>
dimensions	5 modules (88mm)
fixing	on rail TH-35

System with connectors is applied with receiver current exceeding 16A.

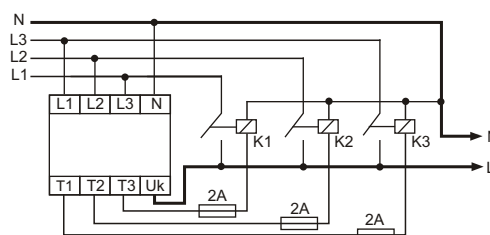

with contactors

# 12. AUTOMATIC TRANSFER SWITCHING EQUIPMENT

## PURPOSE

Automatic transfer switching equipment is used to control the work performance and accuracy of power lines and automatic switching power supply facility sources in the event of power line parameters decrease or total loss of voltage on the line.

## SZR-280 SZR-280/12

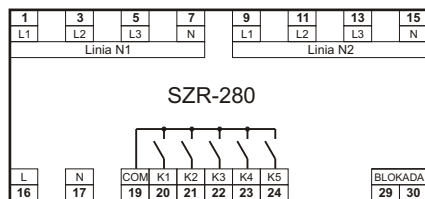

network	3-f 4-wired
controller power supply voltage	85+264V AC
SZR-280	12V AC/DC
power consumption	<5VA
measured input voltage	230V
rated voltage	80+300V
measuring range	45+50Hz
frequency	1% full scale + 1 digit
accuracy	
relay outputs	
contacts	5×1Z
load	<8A
states indication	7×LED
working temperature	10+50°C
connection	zaciski śrubowe 2,5mm <sup>2</sup>

## FUNCTIONS

- \* Simultaneous control of two power lines
- \* Measured values TrueRMS
- \* Galvanic separation of measuring inputs supply lines
- \* Contactors control
- \* Support for an emergency generator exhaust
- \* Working in automatic mode, with the possibility of determining the priority line
- \* Power Dump is achieved through separation of the receiving line into two parts, with possibility to freely define of the power dump cases
- \* An independent determination of voltage range for each of the line for which line qualified as good, and the voltage hysteresis determination of the line qualifications
- \* The definition of eligibility as a good line, and the time of qualification as a bad line.
- \* Accelerated classification as a bad line in case of total loss of voltage on the line
- \* The definition of time-controlled switching on and off contactors
- \* Ability to connect to an external safety circuit lock the controller work
- \* Configure the driver through a PC using a dedicated application
- \* Events registration with the possibility of export of the registration file to your PC

## WORK MODES

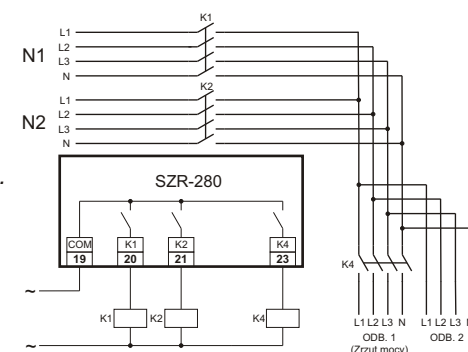
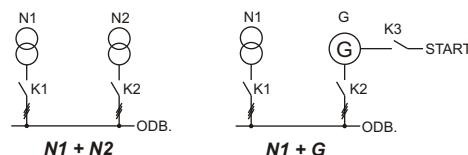

## SZR-281



network	3-f 4-wired
Controller power supply voltage	85+264V AC
reserve voltage	16+27V DC
power consumption (main/reserve)	<5VA / <10W
measured input voltage	230V
rated voltage	80+300V
measuring range	45+50Hz
frequency	1% full scale + 1 digit
accuracy	
relay outputs	
contacts	8×1Z + 1×1Z(ALARM)
load	<8A / <2A(ALARM)
States indication	4×LED
Working temperature	10+50°C
connection	zaciski śrubowe 2,5mm <sup>2</sup>
dimensions [mm]	width 150 height 75 depth 110
fixing	on rail TH-35

## WORK MODES

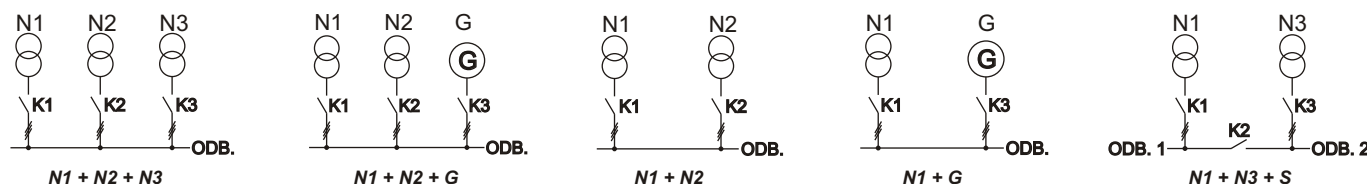

**FUNCTIONS**

- \* Simultaneous control of three power lines
- \* Measured TrueRMS value
- \* Galvanic separation of measuring inputs lines supply
- \* Control voltage presence on the receiving line
- \* Controlling contactors or motorized connectors
- \* Support for an emergency exhaust generator
- \* Working in automatic mode, with the possibility of determining the priority line
- \* Power Dump is achieved through separation of the receiving line into two parts, with possibility to freely define of the power dump cases
- \* An independent determination of voltage range for each of the line for which line qualified as good, and the voltage hysteresis determination of the line qualifications
- \* The definition of eligibility as a good line, and the time of qualification as a bad line.
- \* Accelerated classification as a bad line in case of total loss of voltage on the line
- \* The definition of time-controlled switching on and off contactors / motor connector
- \* Ability to connect to an external safety circuit lock the controller work
- \* Setting and monitoring of the driver through the front panel controller with LCD display and keypad
- \* Setting and monitoring of the controller through a PC using a dedicated application
- \* Event registration with the possibility of export of the registration file to your PC
- \* Signaling errors achieved through contact and buzzer alarm
- \* Ability to controller supplying by reserve voltage 24V DC

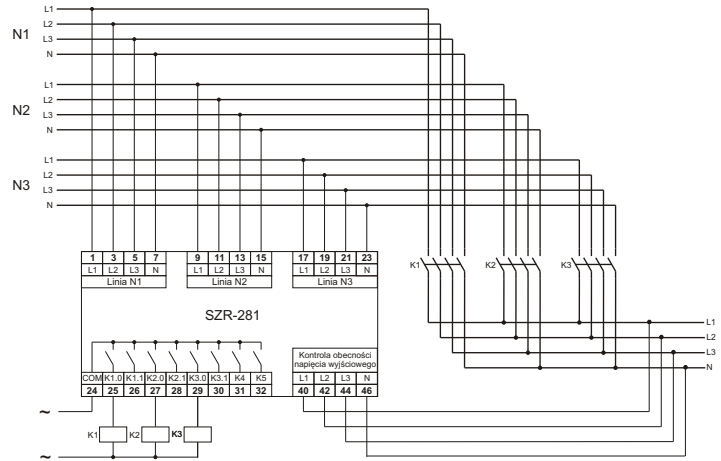

**APPLICATION**

Application support controller ATSE works in Windows 2000/XP/Vista/7 system and meets the minimum hardware requirements for these systems + monitor resolution min. 1024x768 points.

**MAIN PROGRAM FUNCTION**

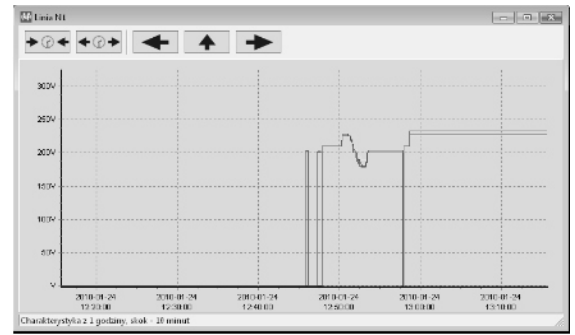
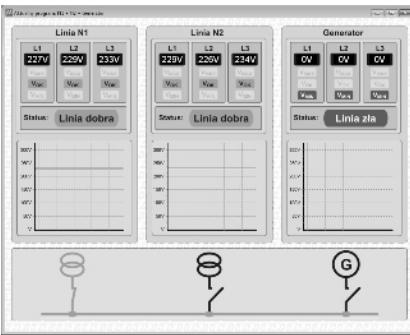

**Program.** Display information window with the currently executed program.

**Register.** Display window registry events.

**Monitor.** Current voltage values on the inputs lines of the controller and browsing history.

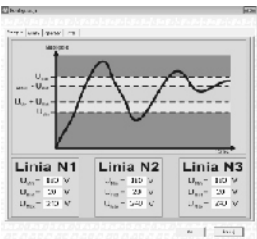

**Configuration: Voltage**  
Setting of the parameters defining the limits of voltage minimum and maximum on each power supply lines, and the width of the hysteresis zone.

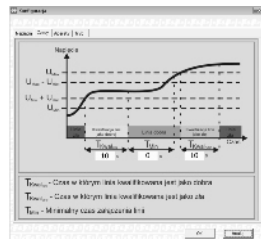

**Configuration: Time**  
Setting of the duration of the qualification as a line of good and bad, and the minimum time for which the power line is attached.

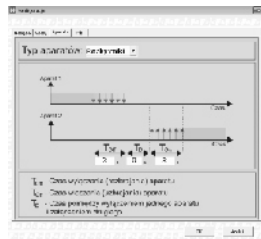

**Configuration: Devices**  
Setting the parameters associated with the types and characteristics of the devices connected to the controller (motor contactors or switches), sometimes switching on and off the devices, and the time interval between one except the device and attaching a second one.

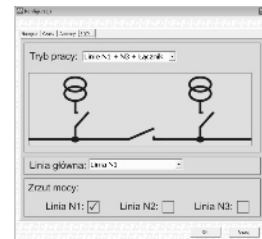

**Configuration: Working mode**  
Working mode program controller selection, choice of main line, and the line selection, which is implemented power dump.

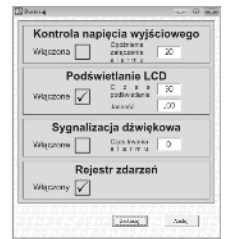

**System configuration:**  
- output voltage control  
- the LCD backlight  
- the sound of the siren  
- activation of the log registration

# 13.

# TIMING RELAYS

## PURPOSE

Timing relays are devised to time the control of industrial and domestic automatic control engineering systems (e.g. ventilation, heating, lighting, signalling, etc.).

## Operation mode: LAGGED DEACTIVATION

### PCA-512

### PCA-514

## FUNCTIONING

Until the relay is activated, the contact remains in the 11-10 position. After the power voltage is supplied, contact is shifted to position 11-12 and the countdown of the preset value  $t$  is commenced. After the preset time  $t$  has been counted down, contact returns to position 11-10. The working sequence of the relay may be repeated after turning the power supply off and on.

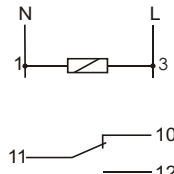
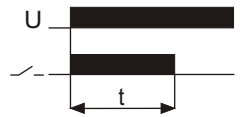

PCA-512

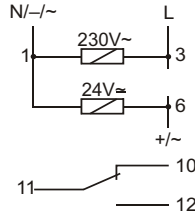

PCA-514

supply	PCA-512 230V	230V AC
	PCA-512 24V	24V AC/DC
	PCA-512 UNI	12+264V AC/DC
	PCA-514 DUO	230V AC / 24V AC/DC
current load		<10A
contacts		1 C/O
operation time		0,1sec+576day
activation lag		<50msec
power supply indicator		green LED
operation mode indicator		red LED
power consumption		0,8W
working temperature		-25+50°C
connection		screw terminals 2,5mm <sup>2</sup>
dimensions		1 module (18mm)
fixing		on rail TH-35

## Operation mode: LAGGED ACTIVATION

## FUNCTIONING

After the power voltage is supplied, the contact remains in position 11-10 and the timing of the preset value  $t$  is commenced. After the preset time  $t$  has been counted down, the contact is shifted to position 11-12. The working sequence of the relay may be repeated after turning the power supply off and on.

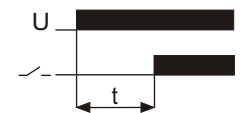

### PCR-513

### PCR-515

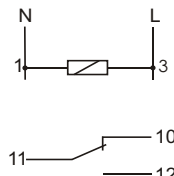

PCR-513

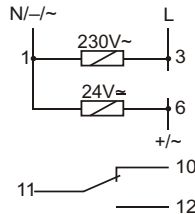

PCR-515

supply	PCR-513 230V	230V AC
	PCR-513 24V	24V AC/DC
	PCR-513 UNI	12+264V AC/DC
	PCR-515 DUO	230V AC / 24V AC/DC
current load		<10A
contacts		1 C/O
operation time		0,1sec+576day
power supply indicator		green LED
operation mode indicator		red LED
power consumption		0,8W
working temperature		-25+50°C
connection		screw terminals 2,5mm <sup>2</sup>
dimensions		1 module (18mm)
fixing		on rail TH-35

## ATTENTION!

- \*Setting the time range knob regulator in the:
  - ON - position with power supply activated results in the permanent closure of the contact .
  - OFF - position (power supply activated) causes the contact to be permanently closed.
- \*With the power supply on, the system does not respond to time range setting modifications.
- \*The newly set time range is active after the power supply has been turned off and on.
- \*With the power supply on, it is possible to regulate the preset time freely within the selected time range.

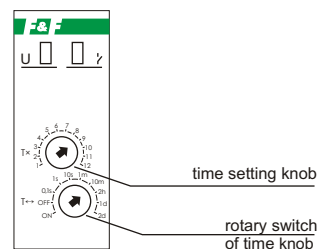

# MULTI-FUNCTION; MULTI-RANGE FUNCTIONING

Operation mode:

**\*LAGGED ACTIVATION (IR)**

After the power voltage is supplied, the contact remains in position 11-10 (and 8-7 for PCU-510) and the timing of the preset value *t* is commenced. After the preset time *t* has been counted down, the contact is shifted to position 11-12 (and 8-9 for PCU-510). The working sequence of the relay may be repeated after turning the power supply off and on.

**\*LAGGED DEACTIVATION (IA)**

Until the relay is activated, the contact remains in the 11-10 (and 8-7 for PCU-510) position. After the power voltage is supplied, contact is shifted to position 11-12 (and 8-9 for PCU-510) and the countdown of the preset value *t* is commenced. After the preset time *t* has been counted down, contact returns to position 11-10 (and 8-7 for PCU-510). The working sequence of the relay may be repeated after turning the power supply off and on.

**\*LAGGED ACTIVATION - CYCLIC (CR)**

The LA operational mode is triggered in equal interruption/work cycles according to the preset time values.

**\*LAGGED DEACTIVATION - CYCLIC (CA)**

The LD operational mode is triggered in equal interruption/work cycles according to the preset time values.

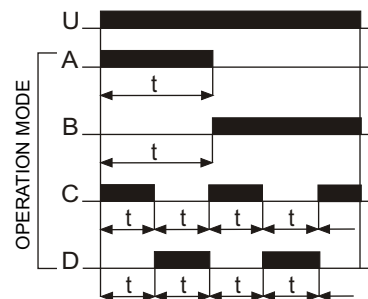

## PCU-510

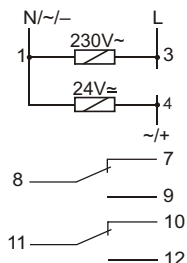

supply PCU-510 DUO	230V AC / 24V AC/DC
current load	2x(<5A)
contacts	2 C/O
operation time	0,1sec+576day
activation lag delay functions	<50msec
power supply indicator	green LED
operation mode indicator	red LED
power consumption	0,8W
working temperature	-25+50°C
connection	screw terminals 2,5mm <sup>2</sup>
dimensions	1 module (18mm)
fixing	on rail TH-35

## PCU-511

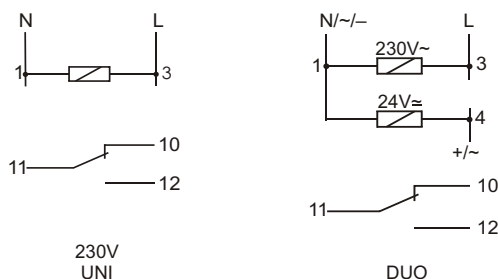

supply PCU-511 230V	230V AC
PCU-511 DUO	230V AC / 24V AC/DC
PCU-511 UNI	12+264V AC/DC
current load	<10A
contacts	2 C/O
operation time	0,1sec+576day
activation lag delay functions	<50msec
power supply indicator	green LED
operation mode indicator	red LED
power consumption	0,8W
working temperature	-25+50°C
connection	screw terminals 2,5mm <sup>2</sup>
dimensions	1 module (18mm)
fixing	on rail TH-35

## PCU-518 WITH EXTERNAL TIME SETTING KNOB

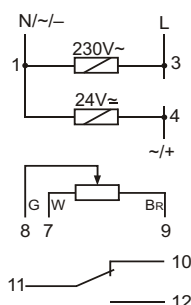

supply PCU-510 DUO	230V AC / 24V AC/DC
current load	<8A
contacts	1 C/O
operation time	0,1sec+576day
activation lag delay functions	<50msec
power supply indicator	green LED
operation mode indicator	red LED
power consumption	0,8W
working temperature	-25+50°C
connection	screw terminals 2,5mm <sup>2</sup>
dimensions	1 module (18mm)
fixing	on rail TH-35
dimensions of knob	63x42x30mm
connection	cabl 3x0,34mm <sup>2</sup> ; l=70cm
fixing hole	Ø10

### ATTENTION!

- \*Setting the time range knob regulator in the:
  - ON - position with power supply activated results in the permanent closure of the contact.
  - OFF - position (power supply activated) causes the contact to be permanently closed.
- \*With the power supply on, the system does not respond to time range setting modifications.
- \*The newly set time range is active after the power supply has been turned off and on.
- \*With the power supply on, it is possible to regulate the preset time freely within the selected time range.

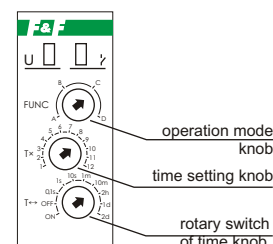

## TWO-TIME TYPE

### SETTING OF TWO INDEPENDENT TIME VALUES T1 AND T2 (work time and interruption time).

Made for 230V AC or 24V AC/DC (special order for 12V, 48V, 110V AC/DC)

#### PCU-520 4-FUNCTION

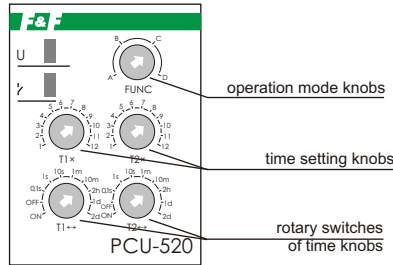
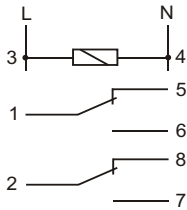

supply	230V AC
	24V AC/DC
current load	2x(<8A)
contacts	2 C/O
operation time	0,1sec+576day
activation lag delay functions	<50msec
power supply indicator	green LED
operation mode indicator	red LED
power consumption	1,2W
working temperature	-25+50°C
connection	screw terminals 2,5mm <sup>2</sup>
dimensions	2 modules (35mm)
fixing	on rail TH-35

Operation mode:

**\*LAGGED ACTIVATION (IR)**

Until the relay is activated, the contact remains in the 1-5 and 2-8 position. After the power voltage is supplied (the green "U" LED lights up), the contact is shifted to 1-6 and 2-7 position and the countdown of the preset value *t* is commenced (the red LED lights up). After the preset time *t* has been counted down, the contact returns to position 1-5 and 2-8. The working sequence of the relay may be repeated after turning the power supply off and on.

**\*LAGGED DEACTIVATION (IA)**

Until the relay is activated, the contact remains in the 1-5 and 2-8 position. After the power voltage is supplied (the green "U" LED lights up), the contact is shifted to position 1-6 and 2-7 and the countdown of the preset value *t* is commenced (the red LED lights up). The working sequence of the relay may be repeated after turning the power voltage off and on.

**\*LAGGED ACTIVATION - CYCLIC (CR)**

The LA operational mode is triggered in equal interruption/work cycles according to preset time values.

**\*LAGGED DEACTIVATION - CYCLIC (CA)**

The LD operational mode is triggered in equal interruption/work cycles according to preset time values.

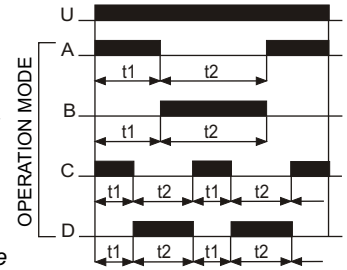

#### PCU-507 2-FUNCTION

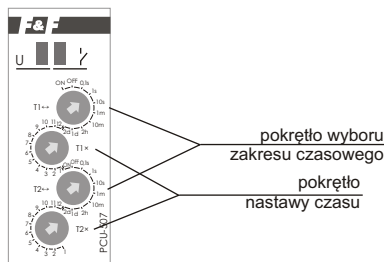
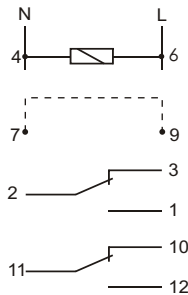

supply PCU-507 230V	230V AC
PCU-507 24V	24V AC/DC
current load	2x(<8A)
joint	separate 2P
work time - adjustable	0,1sec+576h
interval time - adjustable	0,1sec+576h
delay activation to averse function	<50msec
power supply indicator	green LED
operation mode indicator	red LED
power consumption	0,8W
working temperature	-25+50°C
connection	screw terminals 2,5mm <sup>2</sup>
dimensio	

Functions:

**- DELAYED ON - CYCLIC:**  $\overline{7} \uparrow \times \downarrow 9$

When the power supply is given then joints remain in the positions 2-3 and 11-10 for the time *t*<sub>1</sub>. After the preset time *t*<sub>1</sub> switches the joints in position 2-1 and 11-12 at the time *t*<sub>2</sub>. After time *t*<sub>2</sub> the relay joints return to the positions 2-3 and 11-10. The sequence of these switches is carried out periodically.

**- DELAYED OFF - CYCLIC:**  $\overline{7} \downarrow \square \downarrow 9$

To time of switching the relay, the joints remain in the positions 2-3 and 11-10. After the power supply is given then joints are switched to position 2-1 and 11-12 at the time *t*<sub>1</sub>. After the preset time *t*<sub>1</sub> joints return to the positions 2-3 and 11-10 for the time *t*<sub>2</sub>. The sequence of these switches is carried out periodically.

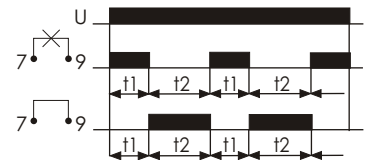

Selection of a particular function is make by jumper on terminals 7-9.

\*Setting the time range knob regulator in the:

ON - position with power supply activated results in the permanent closure of the contact in position 1-6 and 2-7.

OFF - position (power supply activated) causes the contact to be permanently closed in the 1-5 and 2-7 position.

\*With the power supply on, the system does not respond to time range setting modifications.

\*The newly set time range is active after the power supply has been turned off and on.

\*With the power supply on, it is possible to regulate the preset time freely within the selected time range.

# MULTI-FUNCTION; MULTI-RANGE

## PCS-506 8 FUNCTION

with START control input

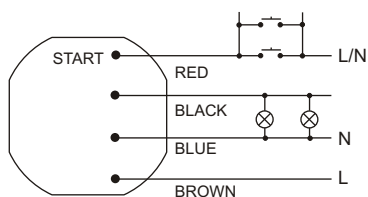

### Setting of operation mode and time range

The required time range and the operation mode of the relay is selected by choosing the proper combination of the switches (black field in the diagram stands for the switch position).

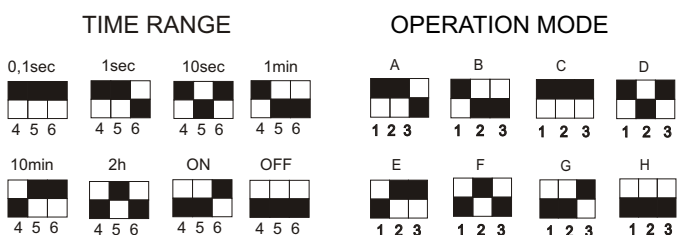

Setting the wheel regulator in the:

**\*ON** position with power supply activated causes the contact to be permanently closed.

**\*OFF** position with power supply activated causes the contact to be permanently opened.

*\*With the power supply on, the system does not respond to time range setting modifications.*

*\*The newly set time range is active after the power supply has been turned off and on.*

*\*With the power supply on, it is possible to regulate the preset time freely within the selected time range.*

supply	230V AC
current load	<10A
contacts	1 N/O
operation time	0,1sec+24h
activation lag delay function	<50msec
power supply indicator	green LED
operation mode indicator	red LED
power consumption	0,8W
working temperature	-25+50°C
connection	4×1mm <sup>2</sup> ; l=10cm
dimensions	Ø55, h=13mm
fixing	to under plaster box Ø60



Presence simulator. When the START signal is being applied, the system turns the relay on and off at random for a period of 20sec. up to 20 min. The sequence in question is initiated by activation of the relay. After the START signal is discontinued, the system turns the relay off. The device does not respond to time range settings.

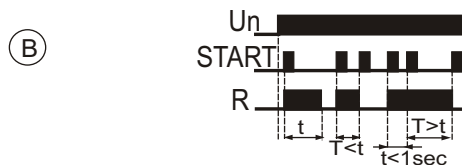

Bistable relay with step automatic module. A single pressing of the START button results in activating the relay for the preset time. A further START impulse generated during the countdown will deactivate the relay. Two START impulses applied within a time shorter than 1sec. will result in the permanent activation of the relay. The following impulse turns the relay off.

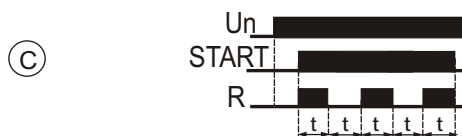

Generator with a pulse duty factor of 50% which initiates its working sequence from the moment of activation. It is active as long as START voltage is applied. Once the START signal is disconnected, the connection is broken and the device is deactivated.

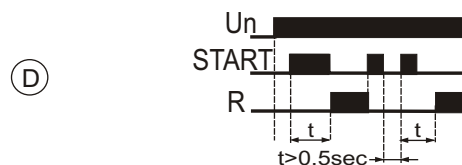

Lagged activation of the relay with the START signal. When the relay is active, another START impulse will turn it off. The following START impulse causes a repetition of the time countdown sequence and activation of the relay. The interval between the trailing edge of the reset signal and the leading edge of the START signal, which re-initiates the countdown sequence, should be at least 0,5sec.

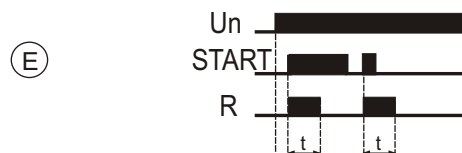

Generation of a single impulse of t time by the START signal trailing edge. During preset time countdown, the system does not respond to START impulses.

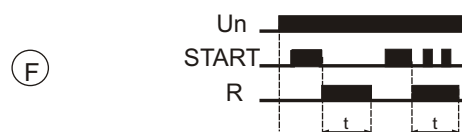

Generation of a single impulse of t time by the START signal trailing edge. During preset time countdown, the system does not respond to START impulses.

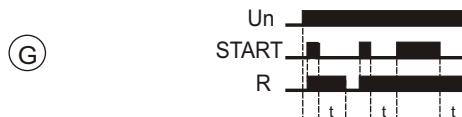

Lag in deactivation with support function enabled. The leading edge of the START signal results in relay activation, whereas the trailing edge of the same signal triggers the time countdown. The supply of the START signal during countdown results in an extension of the cycle by another t time value along the trailing edge.



Deactivation and activation lags with support function enabled. If the START voltage is supplied for less than 45sec., it is ignored by the system, however if it is longer, the relay is activated after the 45sec. and the preset time value is counted down with the trailing edge of the START signal. If another START impulse is applied during the countdown, then the trailing edge of this signal will result in the repeated countdown sequence (e.g. for ventilation purposes: short activation of the lighting does not turn the fan on, but if the lighting is activated for longer than the 45sec., the fan will start).

# PCU-516 PCU-519 10-FUNCTION

with START i RESET control inputs



Using operation mode knob set the one of the functions.

If the RESET voltage is applied during the execution of:  
 \*A, B, C, D, F functions the 'selected operation' mode is restarted  
 \*F, G, H, I functions the relay returns to the initial condition and awaits the START signal;  
 \*K function the relay's contact is closed permanently in the 3-7 position.

\*Setting the time range knob regulator in the:  
 ON - causes permanent activation of contacts  
 OFF - causes permanent deactivation of contacts

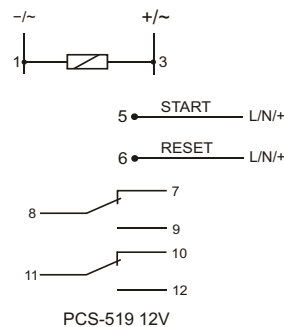
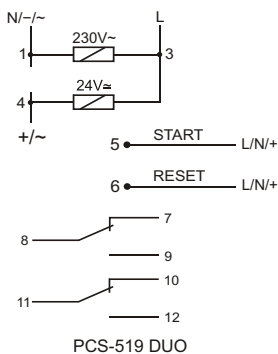
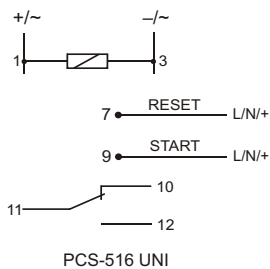
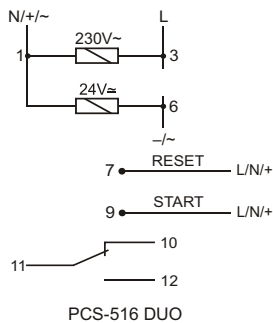

power supply	PCS-516 DUO	230V AC / 24V AC/DC
	PCS-516 UNI	12+264V AC/DC
	PCS-519 DUO	230V AC / 24V AC/DC
	PCS-519 12V	12V AC/DC
current load	PCS-516	<8A
	PCS-519	2x[<8A]
contact	PCS-516	1C/O
	PCS-519	2C/O
working time		0,1s +576h
activation delay		< 50ms
signaling power		green LED
signaling contact status		red LED
power consumption		0,8W
work temperature		-25+50°C
connection		screw terminals 2,5mm <sup>2</sup>
dimensions		1 module (17,5 mm)
fixed		on rail TH-35



### LAGGED ACTIVATION

After the power voltage is supplied, the contact remains in position 3-5 and the timing of the preset value  $t$  is commenced. After the preset time  $t$  has been counted down, the contact is shifted to position 3-7. The working sequence of the relay may be repeated after turning the power supply off and on.

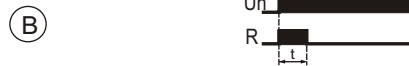

### LAGGED DEACTIVATION

Until the relay is activated, the contact remains in the 3-5 position. After the power voltage is supplied, the contact is shifted to position 3-7 and the countdown of the preset value  $t$  is commenced. The working sequence of the relay may be repeated after turning the power voltage off and on.

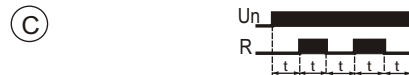

### LAGGED ACTIVATION - CYCLIC

The LA operational mode is triggered in equal interruption/work cycles according to preset time values.

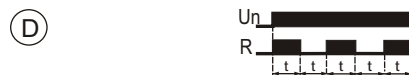

### LAGGED DEACTIVATION - CYCLIC

The LD operational mode is triggered in equal interruption/work cycles according to preset time values.

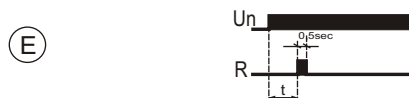

0,5sec. impulse generation after preset time  $t$

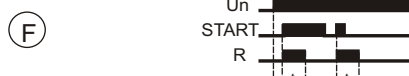

Generation of a single impulse of  $t$  time by the START signal leading edge. During preset time countdown, the system does not respond to START impulses.

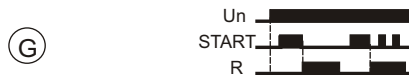

Generation of a single impulse of  $t$  time by the START signal trailing edge. During preset time countdown, the system does not respond to START impulses.

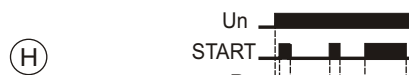

Lag in deactivation with support function enabled. The leading edge of the START signal results in relay activation, whereas the trailing edge of the same signal triggers the time countdown. The supply of the START signal during countdown results in an extension of the cycle by another  $t$  time value along the trailing edge.

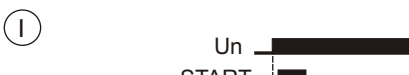

The generate a single pulse 0.5 sec after time  $t$  activated by the trailing edge of the signal START



The brake on  $t$  time in activation of the contact is activating of the rising edge of the START signal.



# PCS-517 18-FUNCTION

with START control input

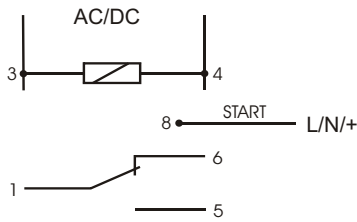

## ATTENTION!

Wide range of time adjustment positions (0.25 sec. - 99 hrs 59mins 59secs) enables the user to preset an extremely accurate contact actuation time, e.g. 2hrs - 13mins - 27secs.

Supply	24+264V AC/DC
Current load	<16A
contacts	separated 1C/O
Control pulse current	<1mA
Operation time	0,25sec+99h59min59sec
activation lag delay function	500msec
Power consumption	1,5W
Working temperature	-20+50°C
Terminal	screw terminals 2,5mm <sup>2</sup>
Dimensions	2 modules (35mm)
Fixing	on rail TH-35

### P00 IDLE MODE

#### P01



After supply voltage has been applied, the contact remains in 1-6 position and countdown of the preset delay time  $t$  is commenced. After this time is counted down, the contact is switched to position 1-5 (actuation). The next run of the relay's working sequence is operable when the supply voltage is reinstated after cut-off.

#### P02



Until the supply voltage is applied, the contact remains in 1-6 position. Once the voltage is applied, the contact is switched to position 1-5 (actuation) and countdown of the preset delay time  $t$  is commenced. The next run of the relay's working sequence is operable when the supply voltage is reinstated after cut-off.

#### P03



Delayed actuation work mode is realised in cycles with the following preset time interruptions:  $t_1$  interruption and  $t_2$  work (actuation).

#### P04

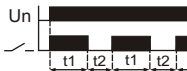

Delayed deactivation work mode is realised in cycles with the following preset time interruptions:  $t_1$  actuation and  $t_2$  interruption.

#### P05

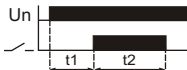

After supply voltage has been applied, the contact remains in position 1-6 and countdown of the preset delay time  $t$  is commenced. After this time is counted down, the contact is switched to position 1-5 (actuation) for time  $t_2$ . The next run of the relay's working sequence is operable when the supply voltage is reinstated after cut-off.

#### P06



Once the START signal is applied, the contact is switched to position 1-5 (actuation). After the signal's decay, the contact is held in the position for the preset  $t$  time. When time  $t$  is counted down, the contact does not respond to the next pulses of the START signal.

#### P07



Once the START signal is applied, the contact is switched to position 1-5 (actuation). After the signal's decay, the contact is held in the position for the preset time  $t$ . Another application of the START signal during countdown time  $t$  results in the countdown interruption, with the contact still actuated (pos. 1-5). Another decay of the START signal triggers off time  $t$  countdown and the contact support in that position.

#### P08



Contact actuation (pos. 1-5) for time  $t$  by the leading edge of the START signal.

#### P09



Delay time  $t_1$  (pos. 1-6) is triggered off by the leading edge of the START signal. After the  $t_1$  time has been counted down, the contact is actuated (pos. 1-6) for the  $t_2$  time.

#### P10

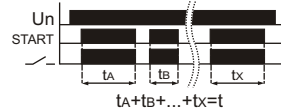

Contact actuation (pos. 1-5) during the countdown of time  $t$  from value set as "zero" only during the application of the START signal. The signal's decay stops the countdown. Another application of the START signal results in the continuation of the countdown for the remaining time  $t$ . The decay of the supply voltage results in the remaining time  $t$  being reset. After the supply voltage and START signal are reinstated, the countdown of time  $t$  from the preset value will be restarted.

#### P11



Contact actuation (pos. 1-5) for time  $t$  with the trailing edge of the START signal. When time  $t$  is counted down, the contact does not respond to the next pulses of the START signal.

#### P12



Contact actuation (pos. 1-5) for time  $t$  with the trailing edge of the START signal. Another application of the START signal, as well as its decay during time  $t$  countdown triggers off the countdown from the beginning.

#### P13



Contact actuation (pos. 1-5) for time  $t$  by the leading edge of the START signal. Another application of the START signal during time  $t$  countdown results in the countdown's interruption and the contact's deactivation (pos. 1-6).

#### P14



Contact actuation (pos. 1-5) for time  $t$  by the leading edge of the START signal. Another application of the START signal during time  $t$  countdown triggers off the countdown from the beginning.

#### P15



Contact actuation (pos. 1-5) for  $t_1$  time by the leading edge of the START signal and another actuation for time  $t_2$  with the trailing edge of the START signal.

#### P16



Contact actuation (pos. 1-5) for time  $t_1$  by the leading edge of the START signal. When time  $t$  is counted down, the contact does not respond to the next pulses of the START signal.

#### P17

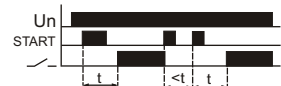

Delayed contact actuation after the lapse of time  $t$ , with the countdown triggered off by the leading edge of the START signal. Another application of the signal deactivates the contact (pos. 1-6) for time  $t$ . A further application of the START signal during time  $t$  countdown triggers off the countdown from the beginning.

#### P18



Delayed contact actuation after the lapse of time  $t$ , with the countdown triggered off by the leading edge of the START signal. When time  $t$  is counted down, the contact does not respond to the next pulses of the START signal. The contact is deactivated (pos. 1-6) on the decay of the supply voltage. The next run of the relay's working sequence is operable after the supply voltage is cut off and reinstated.

# LAGGED-PULSE TIME RELAYS

## PURPOSE

Lagged-pulse time relays are devised to support the power supply of the controlled receiver for a specified period of time after decay of the control voltage, e.g. in bathroom ventilation systems in which the upkeep of the fan operation (activated along with the lighting) is required for a specified period of time after turning off the accompanying lighting.

## FUNCTIONING

The application of control voltage *S* to the relay causes its activation and the resulting supply of voltage *R* to the controlled receiver. After decay of the control voltage, the operation of the receiving device is kept for the support time *t* (preset with the potentiometer). After the *t* time has been counted down, the controlled receiver is turned off automatically. If control voltage *S* is re-supplied before the lapse of the preset time, the relay will repeat its operational sequence.

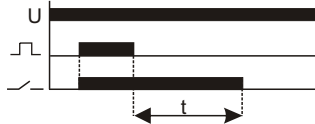

## PO-405

With cable connection.

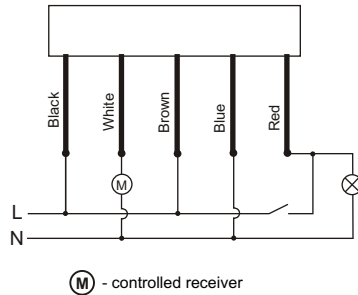
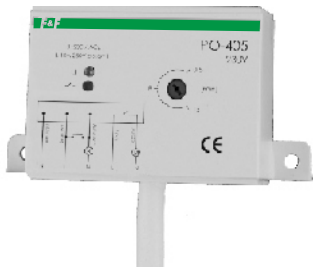

supply PO-405 230V	230V AC
PO-405 24V	24V AC/DC
current load	<10A
contacts	1 N/O
operation time	1+15min
power supply indicator	green LED
operation mode indicator	red LED
power consumption	0,56W
working temperature	-25+50°C
connection	5×0,5mm <sup>2</sup> ; l=0,5m
dimensions	70×50×25mm
fixing	two screws to substrate

## PO-406

To under plaster box.

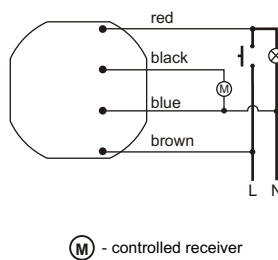

supply	230V AC
current load	<10A
contacts	1 N/O
operation time	1+15min
power consumption	0,56W
working temperature	-25+50°C
connection	wires 4×1mm <sup>2</sup> ; l=10cm
dimensions	Ø55, h=13mm
fixing	to under plaster box Ø60

## PO-415

On rail TH-35

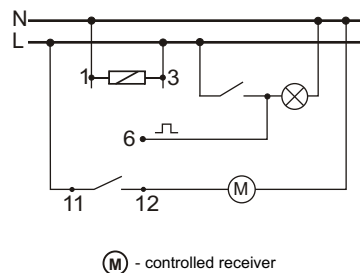

supply PO-415 230V	230V AC
PO-415 24V	24V AC/DC
current load	<10A
contacts	1 C/O
operation time	1+15min
power supply indicator	green LED
operation mode indicator	red LED
power consumption	0,56W
working temperature	-25+50°C
connection	screw terminals 2,5mm <sup>2</sup>
dimensions	1 module (17,5mm)
fixing	on rail TH-35

# 14.

## TIME CONTROLLERS

### STP-541 PROGRAMMABLE CONTROLLER (LEFT/RIGHT activation mode)

With four time settings available and a programmable number of repetitions or infinite work sequence in the "loop mode"

#### PURPOSE

The controller is used for technological process control in industrial automatic-control device systems which require temporal, cyclic and alternate activation of receivers with appropriate intervals between successive switchings.

#### FUNCTIONING

The controller works in compliance with a four-time sequence program and a preset number of cycles. A cycle is a sequence of four successive contact states.

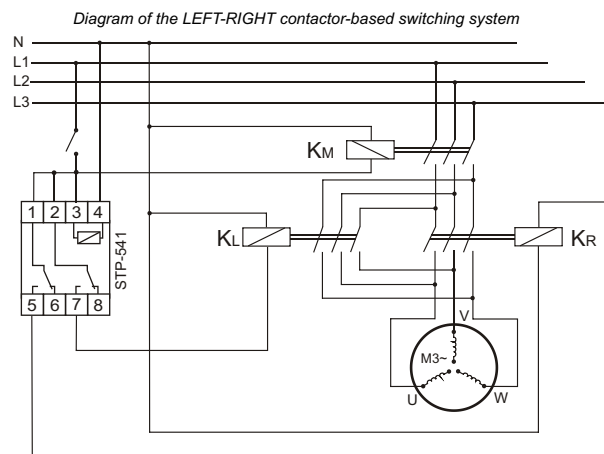

KM - main contactor  
KR - "RIGHT" contactor  
KL - "LEFT" contactor

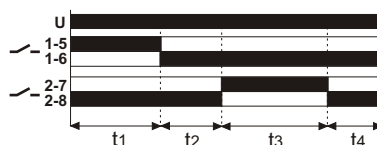
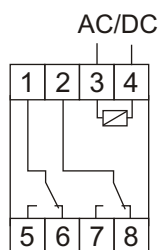

supply	24+264V AC/DC
current load	2x(<16A)
contacts	2x1N/C
time settings t1, t2, t3, t4	1sec+ 99h 59min 59sec
time setting accuracy	1 sec
number of cycle repetitions	1 + 999999
	or infinite in the "loop mode"
power consumption	1.5W
working temperature	-20+50°C
connection	screw terminals 2.5mm <sup>2</sup>
dimensions	2 module (35mm)
fixing	on rail TH-35

### PCG-417 STAR-DELTA SWITCH

To control the STAR-DELTA contactor connection system.

#### FUNCTIONING

The PCG-417 relay is equipped with a special system of two electromagnetic relays which removes the risk of activating two connectors simultaneously, with each relay controlling a given connector. Once the system is switched from STAR to DELTA, one relay disconnects the "star" connector (a forced interval takes place). The other then activates the "delta" connector.

After the power supply is turned on, the contact 7-9 is closed and remains in this position for the preset start-up time t1. After the lapse of t1, contact 7-9 opens and both contacts remain open for the time t2. After the lapse of t2, the contact 10-12 is closed and remains in this position until the power voltage is disconnected.

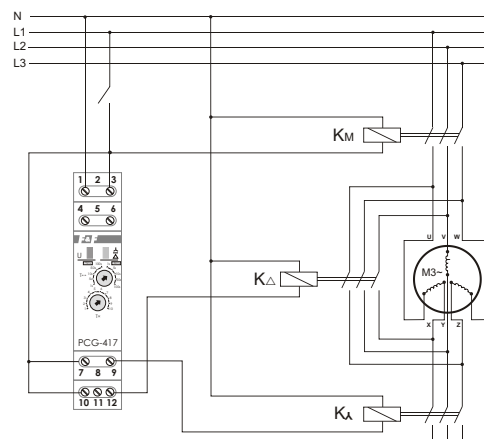

KM - main contactor  
KΔ - contactor "DELTA"  
KΔ - contactor "STAR"

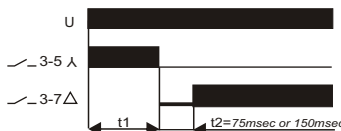
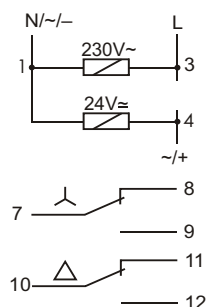

supply	230V AC / 24V AC/DC
current load	2x(<8A)
contact	2x1C/O
start-up time t1	1+1000sec
switching time Δ	75msec / 150msec
power consumption	0.8W
power supply indicator	green LED
action indicator	red LED
working temperature	-25+50°C
connection	screw terminals 2.5mm <sup>2</sup>
dimensions	1 module (18mm)
fixing	on rail TH-35

# 15. PROGRAMMABLE CONTROL TIMERS

## PURPOSE

Programmable control timers are used to control the work time of devices included into industrial or household automatic systems in compliance with individual time schedule planned by the user.

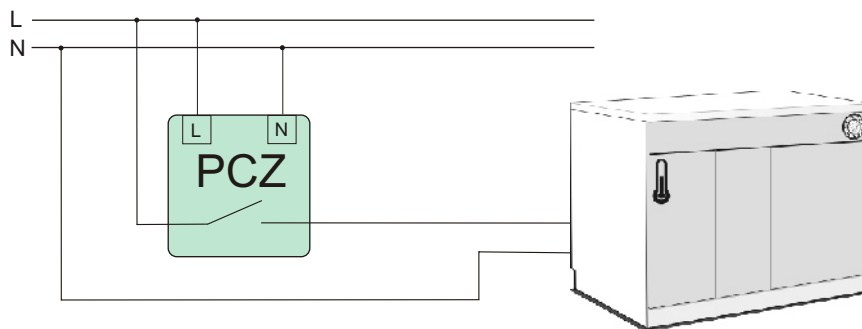

## ATTENTION!

### Daylight Saving Time - automatic change function! (Concerns all types)

Time change from winter to summer occurs automatically at 2 a.m. On the last sunday of March by adding one hour to the current time.

Time change from summer to winter occurs automatically at 3 a.m. on the last sunday of October by taking away one hour from the current time.

ATTENTION! It is possibilities to switch-OFF of automatic change function.

## WEEKLY CYCLES TYPE

### FUNCTIONING

The timer activates and deactivates a given device at preset hours in the following cycles: 24-hour, weekly, working day (Mon-Fri) or weekend (Sat, Sun).

## PCZ-521

One-way type. 250 of program memory sectors.

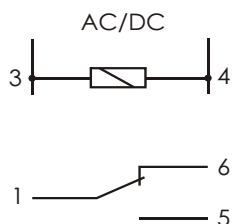

supply	24+264V AC/DC
current load	<16A
contacts	1C/O
display maintenance time	non
timer maintenance time	6 years
indication accuracy item	1sec
time deviation	±1sec/24h
schedule time accuracy item	1min
no. of program memory sectors	250 (125 entry pairs: ON/OFF)
power consumption	1.5W
working temperature	-25+50°C
connection	screw terminals 2,5mm <sup>2</sup>
dimensions	2 modules (35mm)
fixing	on rail TH-35

## PCZ-522

Two-way type. 2×250 of program memory sectors.

With two independent separately programmable ways.

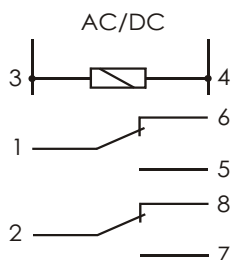

supply	24+264V AC/DC
current load	2×(<16A)
contacts	2×1C/O
display maintenance time	non
timer maintenance time	6 years
indication accuracy item	1sec
time deviation	±1sec/24h
schedule time accuracy item	1min
no. of program memory sectors	2×250 (2×125 entry pairs: ON/OFF)
power consumption	1.5W
working temperature	-25+50°C
connection	screw terminals 2,5mm <sup>2</sup>
dimensions	2 modules (35mm)
fixing	on rail TH-35

# PULSE-TYPE PCZ-523

One-way type with two programme lines.

## FUNCTIONING

The PCZ-523 activates a given device at a preset time and deactivates it after preset time (by pulse) in the following cycles: 24-hour, weekly, working day (Mon-Fri) or weekend (Sat, Sun). Pulse range: 1 sec. + 99 min. 59 sec. The relay has been equipped with two independent switch able programme lines to control an connected receiver.

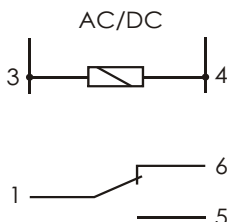

supply	24+264V AC/DC
current load	<16A
contacts	1C/O
display maintenance time	non
timer maintenance time	6 years
indication accuracy item	1sec
time deviation	±1sec/24h
time accuracy item	1s+99min59sec
schedule time accuracy item (pulse)	1sec
no. of program memory sectors 2x(125/per programme line)	
power consumption	1,5W
working temperature	-25+50°C
connection	screw terminals 2,5mm <sup>2</sup>
dimensions	2 modules (35mm)
fixing	on rail TH-35

# ANNUAL TYPE PCZ-529

One-way type

## FUNCTIONING

Time control of devices in domestic or industrial automatic-control device systems according to internal time management program preset by the user. It allows a selection of the superordinate device responsible for seasonal cycles of an automatically controlled system. The timer activates and deactivates a given device to prescheduled dates in the annual cycle. Activation sequence available for a single, selected day of the year.

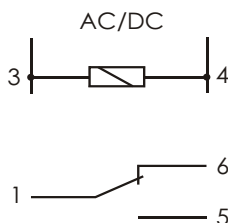

supply	24+264V AC/DC
current load	<16A
contacts	1C/O
display maintenance time	1+2h
timer maintenance time	5+6 weeks
schedule maintenance time	10 years
battery recharge time	30h
Indication accuracy item	1sec
time deviation	±1s/24h
schedule time accuracy item	24h
no. of program memory sectors	198storage cells (99 entry pairs: ON/OFF)
power consumption	1,5W
working temperature	-20+50°C
connection	screw terminals 2,5mm <sup>2</sup>
dimensions	2 modules (35mm)
fixing	on rail TH-35

## Easily programmable! Menu diagram and operational sequence for timer programming.

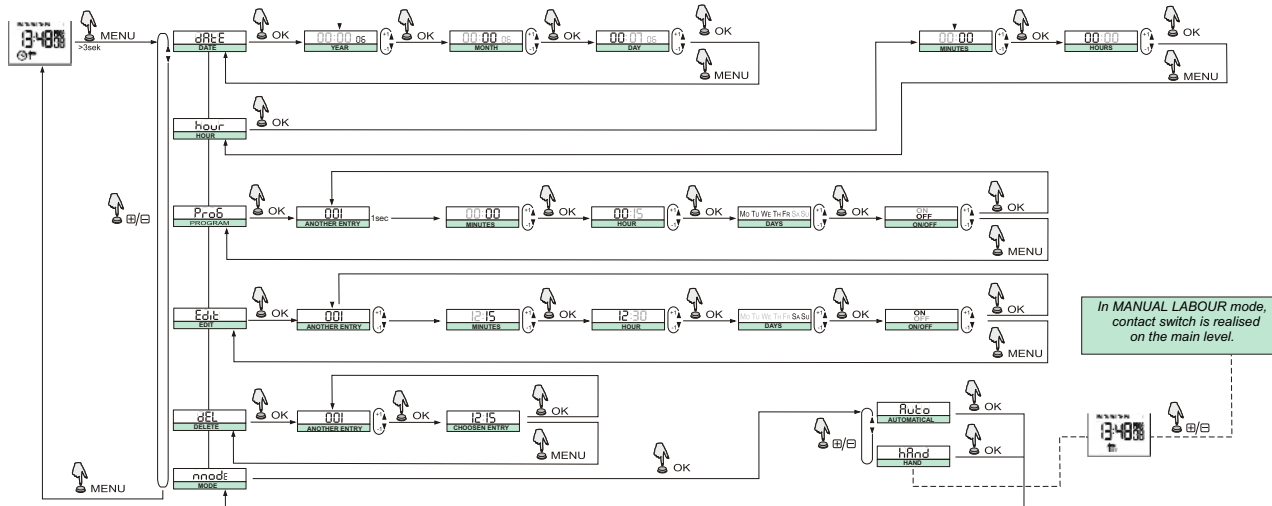

## ASTRONOMICAL TYPE

### FUNCTIONING

The astronomical timer activates and deactivates a device at certain hour, i.e. at sunrise and sunset. Should more settings that are precise be required for locations of different geographical co-ordinates, there is an option to set a given longitude and latitude or select a special code which entails automatic setting of these co-ordinates for a given place in Europe (list of locations and their codes may be found in the manual). Furthermore, there is an option to shift the preset activation/deactivation time for  $\pm 99$  min. for sunrise and sunset times separately.

Code	City	°N	°E	City	Country
1	Praga	50 08	14 25	Prague	CZECHY
2	Plzno	49 47	13 22	Plzen	
3	Budejovice	48 58	14 29	Ceske Budejovice	
4	Brno	49 10	16 37	Brno	
5	Olomouc	49 35	17 15	Olomouc	
6	Ostrava	49 51	18 19	Ostrava	
7	Hradec Kralove	50 13	15 49	Hradec Kralove	
8	Bratislava	48 08	17 05	Bratislava	SLOVACIA
9	Zylina	49 13	18 44	Zilina	
10	Banska Bystrica	48 44	19 08	Banska Bystrica	
11	Poprad	49 03	20 17	Poprad	
12	Koszyce	48 43	21 15	Kosice	WĘGRY
13	Budapeszt	47 30	19 04	Budapest	
14	Debrecen	47 33	21 37	Debrecen	
15	Szeged	46 15	20 08	Szeged	
16	Szombathely	47 13	16 37	Szombathely	
17	Gyor	47 40	17 38	Gyor	
18	Wilno	54 42	25 17	Vilnius	LITWA
19	Kowno	54 54	23 53	Kaunas	
20	Klaipeda	55 41	21 08	Klaipeda	
21	Poniewież	55 43	24 21	Panevezys	
22	Szawle	55 56	23 18	Siauliai	

...

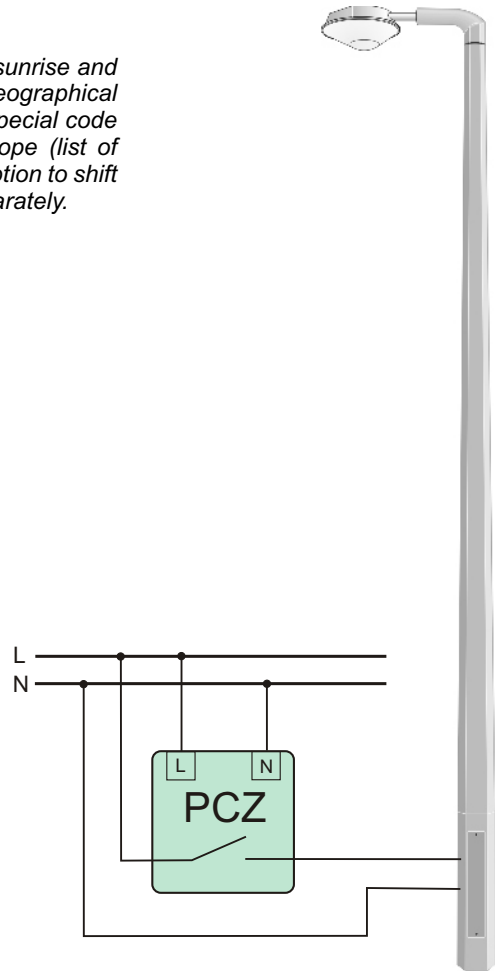

### ATTENTION!

#### Daylight Saving Time - automatic change function! (Concerns all types)

Time change from winter to summer occurs automatically at 2 a.m. On the last sunday of March by adding one hour to the current time.

Time change from summer to winter occurs automatically at 3 a.m. on the last sunday of October by taking away one hour from the current time.

ATTENTION! It is possibilities to switch-OFF of automatic change function.

## PCZ-524 One-way type.

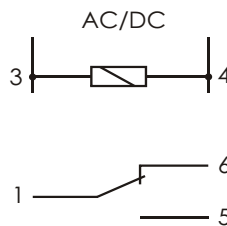

supply	24+264V AC/DC
current load	<16A
contacts	1C/O
display maintenance time	non
timer maintenance time	6 years
indication accuracy item	1sec
time deviation	$\pm 1$ sec/24h
schedule time accuracy item	1min
activation/deactivation time correction	$\pm 0+99$ min
schedule correction accuracy item	1min
power consumption	1,5W
working temperature	-25+50°C
connection	screw terminals 2,5mm <sup>2</sup>
dimensions	2 modules (35mm)
fixing	on rail TH-35

**WITH PROGRAMMEABLE NIGHT INTERVAL (PCZ-525.2, PCZ-526.2)**

**FUNCTIONING**

Like PCZ-524.2. Another feature enables the user to set the so-called night interval between the pre-programmed actuation times, i.e. turning off the controlled receiver for a given period  $t$  (e.g. from 11 p.m. ( $t_1$ ) to 04.00 a.m. ( $t_2$ )).

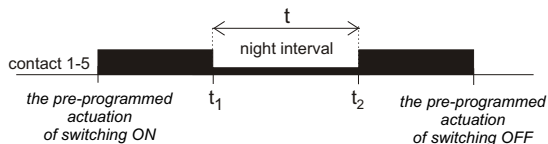

**PCZ-525** One-way type.

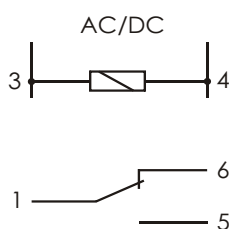

supply	24+264V AC/DC
current load	<16A
contacts	1C/O
display maintenance time	non
timer maintenance time	6 years
schedule maintenance time	1sec
battery recharge time	±1sec/24h
indication accuracy item	1min
time deviation	±0+99min
schedule time accuracy item	1min
activation/deactivation time correction	00:00+24:00
schedule correction accuracy item	1.5W
interval time setting range	-25+50°C
power consumption	screw terminals 2,5mm <sup>2</sup>
working temperature	2 modules (35mm)
connection	on rail TH-35
dimensions	
fixing	

**PCZ-526** Two-way type

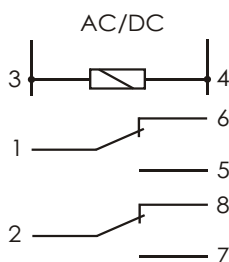

supply	24+264V AC/DC
current load	<16A
contacts	2x1C/O
display maintenance time	non
timer maintenance time	6 years
schedule maintenance time	1sec
indication accuracy item	1min
time deviation	±1sec/24h
schedule time accuracy item	1min
activation/deactivation time correction	±0+99min
schedule correction accuracy item	1min
interval time setting range	00:00+24:00
power consumption	1,5W
working temperature	-25+50°C
connection	screw terminals 2,5mm <sup>2</sup>
dimensions	2 modules (35mm)
fixing	on rail TH-35

# 16. POWER CONSUMPTION LIMITERS

## PURPOSE

Power consumption limiters are devised for the automatic disconnection of power from the circuit of single-phase wiring systems once the rated power

## FUNCTIONING

The limiter enables the user to supply power to the circuit if the total consumed power applied to the receivers constituting the system is lower than the preset value on the limiter's scale. Once the rated power consumption threshold in the controlled circuit is exceeded, the element is automatically disconnected from the power source. The supply is reinstated automatically once the preset time lapses. If the value of power consumption remains over the rated input, the power supply to the circuit is cut off again.

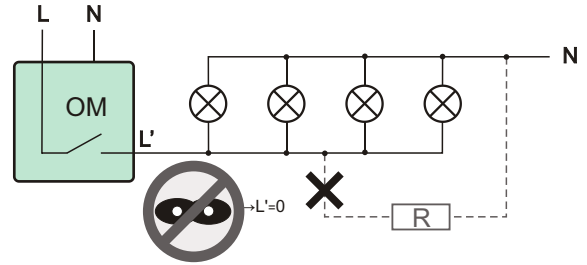

- OM-1** POWER SUPPLY RETURN: 30SEC.
- OM-2** ADJUSTABLE POWER SUPPLY RETURN: 4÷150SEC.

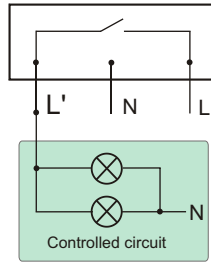

supply	180÷240V AC
current load	<16A
power limit	200÷2000 VA
activation lag	1,5÷2sec
power supply return	
OM-1 (factory setting)	30sec
OM-2 (to set)	4÷150sec
power consumption	0,8W
working temperature	-25÷50°C
connection	screw terminals 2,5mm <sup>2</sup>
dimensions	26×50×67mm
fixing	two screws to substrate

## OM-631

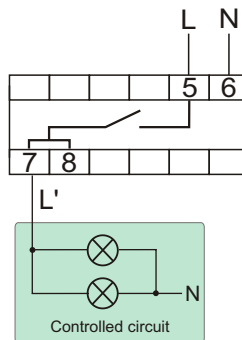

supply	180÷240V AC
current load	<16A
power limit	200÷2000 VA
activation lag	1,5÷2sec
power supply return	30sec
power consumption	0,8W
working temperature	-25÷50°C
connection	screw terminals 2,5mm <sup>2</sup>
dimensions	3 modules (52,5mm)
fixing	on rail TH-35

## FOR CIRCUITS WITH CONVERTERS

### OM-632

Limiter adapted for the protection of circuits with converters, e.g. fluorescent lamps, transformers.

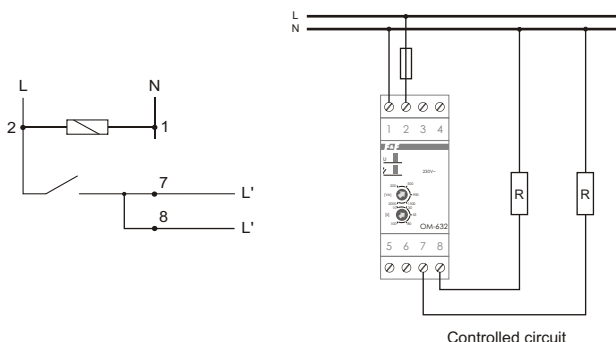

supply	180÷240V AC
contact	10
current load for cosφ=1	<16A
for cosφ≠1	<4A
power limit	200÷1000 VA
activation lag	1,5÷2sec
power supply return	10÷100sec
power consumption	0,8W
working temperature	-25÷50°C
connection	screw terminals 2,5mm <sup>2</sup>
dimensions	2 modules (35mm)
fixing	on rail TH-35



## TO WORK WITH A CURRENT TRANSFORMER

### OM-611

The relay is adapted to cooperate with current transformer whose primary circuit is connected to the circuit to be measured, and output terminals for measuring the OM, which allows for control circuits of any load and the actual setting of the relay activation threshold higher than 5A ( $I_{OM}$ ). Range of measured current dependence on the transmission transformer for example, from 5A to 50A with the transmission ratio of 10:1 for the transformer 50/5A.

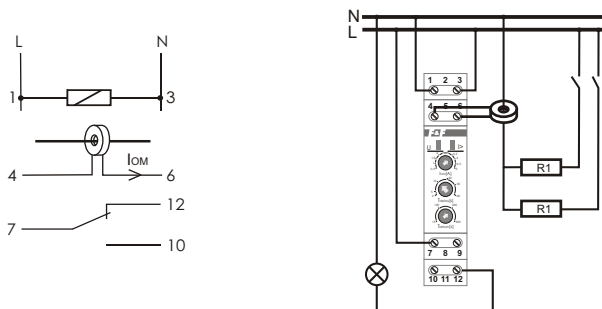

supply	180+240V AC
contact	1C/O
current load	<10A
actuation threshold adjustable	0,5+5 A
actuation delay adjustable	2+40sec
power supply recovery hysteresis	2%
power supply recovery time adjustable	15+300sec
power consumption	0,8W
working temperature	-25+50°C
connection	screw terminals 2,5mm <sup>2</sup>
dimensions	1 module (18mm)
fixing	on rail TH-35

## WITH STAIRCASE TIMER

### OMS-635

The OMS-635 power consumption limiter allows the user to maintain lighting in halls, staircases or other places active for a specified time when it will then turn off automatically. The user may also preset the automatic disconnection of power supply to a single-phase wiring system if the rated power input to the receivers in a given circuit is exceeded.

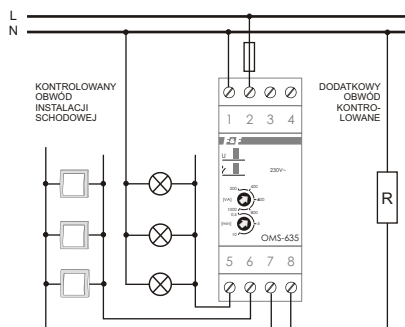

supply	180+240V AC
current load	<10A
power limit	200+1000VA
switching off delay (to set)	0,5+10min
activation lag	1,5+2sec
power supply return	30sec
work time setting range	0,5+10min
power consumption	0,8W
working temperature	-25+50°C
connection	screw terminals 2,5mm <sup>2</sup>
dimensions	3 modules (52,5mm)
fixing	on rail TH-35

## THREE-PHASES

### OM-630 the direct measurement of the 50kW

### OM-630-2 for use with current transformers 5A

#### LIMITER FEATURES (depending on program version)

- measurement of three-phase active power
- three variants of calculation power (for different types of load)
- control of asymmetry, phase sequence and the presence of
- circuit protection
- function relay priority
- a function of three-phase voltage relay
- time lock limiter due to frequent exceedances of the threshold set
- alarm limit value is exceeded capacity
- regulation of activation and return time

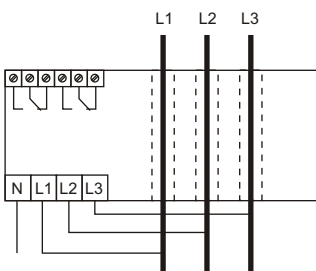
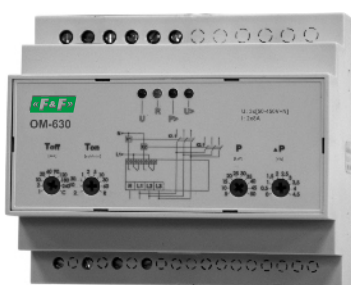

power supply	3x[50+450V+N]
joint	separate 2x1P
load	2x8A
POWER	
activation threshold-regulated	5+50kW
setting precision	0,5kW
activation time Toff -regulated	1+240sec
return time Ton - regulated	2+3600sec
VOLTAGE	
activation threshold	
up	<160V
down	>260V
activation time	
up	5sek
down	0,1sek
measurement precision	
voltage 50+300V	<2%
current 3+100	<3%
hole diameter transformer	10mm
power consumption	
working temperature	-25+50°C
dimensions	6 modules (105mm)
fixing	on the rail TH-35



internal circuits of current transformers

# 17. PRIORITY RELAYS

## PURPOSE

Priority relays are designed to control the value of current drawn by electric receivers and their control units in cases where their simultaneous work could result in circuit overload or current overload protection activation.

## FUNCTIONING

The potentiometer sets the value of drawn current (from 2A to 15A; for PR-615: from 4A to 30A) in the priority circuit, above which the receiver cuts off the non-primary circuit. A drop in current consumption in the priority circuit below the set threshold value will result in an automatic activation of the non-priority circuit. In cases where the priority receiver is already activated, the priority relay will prevent the activation of the non-priority receiver.

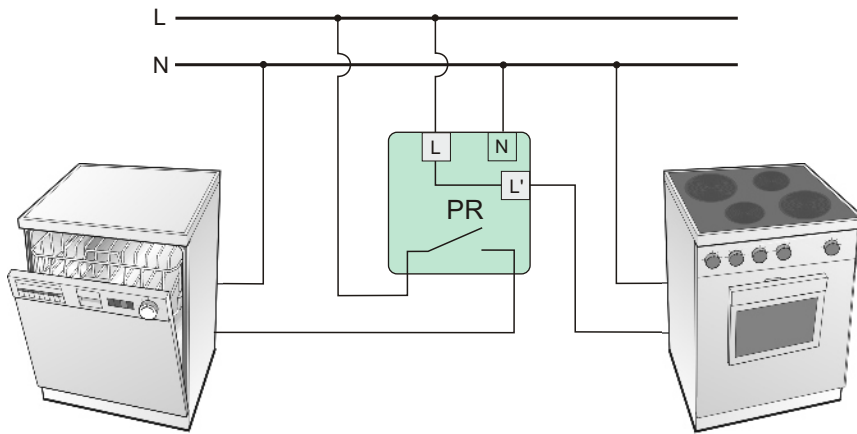

## ATTENTION!

Circuits equipped with master relays require over-current security devices with increased actuation time, in order to prevent them operating before actuation of the relay.

## PR-602 SETTING RANGE: 2÷15A

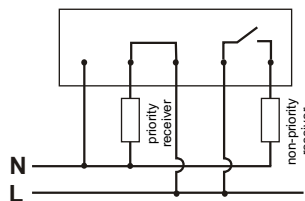

supply	230V AC
non-priority receivers current	<16A or higher with the use of a contactor
priority receivers current	<15A
contact	1 N/O
activation threshold	2÷15 A (priority circuit)
recovery hysteresis	10%
cut off delay	0,1sec
plug in delay	0,1sec
power consumption	0,4 W
dimensions	50×67×26 mm
terminal	screws terminal 2,5mm <sup>2</sup>
fixing	2 screws to substrate

## PR-612 SETTING RANGE: 2÷15A

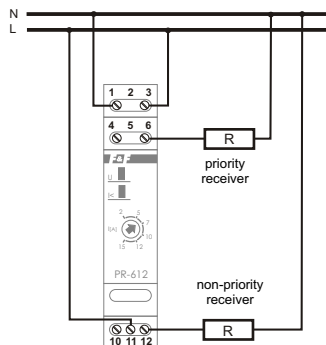

supply	230V AC
non-priority receivers current	<16A or higher with the use of a contactor
priority receivers current	<15A
contact	1 C/O
activation threshold	2÷15 A (priority circuit)
recovery hysteresis	10%
cut off delay	0,1sec
plug in delay	0,1sec
power consumption	0,4 W
terminal	screw terminals 2,5mm <sup>2</sup>
dimensions	1 module (18mm)
fixing	on rail TH-35

## WITH THE RECEIVER'S CURRENT CORD SECTION (GALVANIC SEPARATED FROM THE MEASUREMENT SYSTEM)

### PR-603 SETTING RANGE: 2÷15A

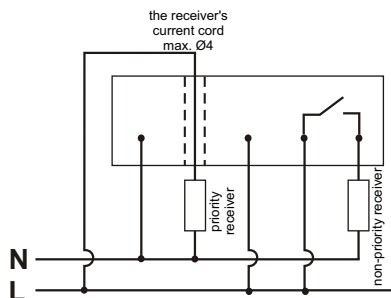

supply	230V AC
non-priority receivers current	<16A
priority receiver current	or higher with use of contactor limited by the cross-section of the receiver cable (max Ø=4 mm)
contact	1 N/O
activation treshold	2+15A (priority circuit)
recovery hysteresis	10%
cut off delay	0,1sec
plug in delay	0,1sec
working temperature	-25+50°C
power consumption	0,4W
connection	screw terminals 2,5mm <sup>2</sup>
dimensions	26×50×67mm
fixing	two screws to substrate

### PR-613 SETTING RANGE: 2÷15A

### PR-615 SETTING RANGE: 4÷30A

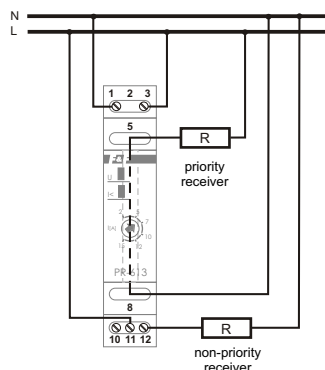

supply	230V AC
non-priority receivers current	<16A
priority receiver current	or higher with use of contactor limited by the cross-section of the receiver cable (max Ø=4 mm)
contact	1 N/O
activation treshold PR-613	2+15A (priority circuit)
PR-614	4+30A (priority circuit)
recovery hysteresis	10%
cut off delay	0,1sec
plug in delay	0,1sec
working temperature	-25+50°C
power consumption	0,4W
connection	screw terminals 2,5mm <sup>2</sup>
dimensions	1 modules (18mm)
fixing	on rail TH-35

Priority receiver current can be higher than 15A. It is only restricted by the receiver's current cord section (galvanic separated from the measurement system) revved through the relay's throughway channel.

## TO CO-OPERATION WITH A CURRENT TRANSFORMER

### PR-614

The relay is designed to work with the current transformer with secondary current 5A. Transformer primary circuit is included in the priority receiver circuit, and secondary to the measurement relay terminals.

Example: For the receiver a priority for a maximum load of 140A we use the parameters of current transformer 150/5A. Torque is 30 at setting values on a scale equal to 2A relay will work with the actual value of current equal to 60A (2A×30=60A).

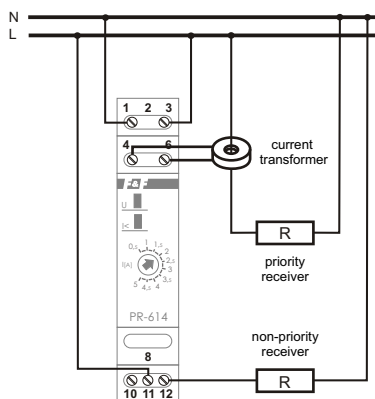

supply	230V AC
non-priority receivers current	<16A
priority receiver current	or higher with use of contactor or increased with the use of current transformer
contact	1 C/O
activation treshold	2+15A (priority circuit)
recovery hysteresis	10%
cut off delay	0,1sec
plug in delay	0,1sec
working temperature	-25+50°C
power consumption	0,4W
connection	screw terminals 2,5mm <sup>2</sup>
dimensions	1 modules (18mm)
fixing	on rail TH-35

# 18.

# CURRENT RELAYS

## PURPOSE

Current relays are used to control the flow of current in the circuit measured with the function switch contact in case of exceeding the value of current intensity above set thresholds.

## EPP-619 WITH RECEIVER'S CURRENT CORD SECTION. (GALVANIC SEPARATED FROM THE MEASUREMENT SYSTEM)

Adjustable potentiometer value is the measured intensity of the current circuit, above which the contact is closed (pos. 11-12). Intensity of the current decline in value below the set threshold will automatically open contact (item 11-10).

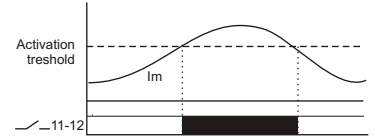
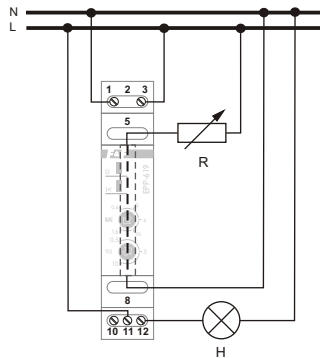
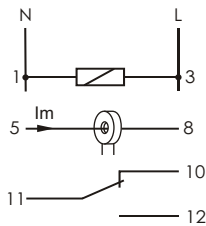

supply	230V AC
contact	separated 1P
current load	<16A
circuit current measured	limited cross-section of the cable (max. Ø=4mm)
current switch - adjustable	0,6÷16A
return hysteresis	10%
actuation time - adjustable	0,5÷10sec
return time	0,5sec
power consumption	0,4Wworking
temperature	-25÷50°C
connection	screw terminal 2,5mm <sup>2</sup>
dimensions	1 module (18mm)
fixing	on rail TH-35

## EPP-620 FOUR FUNCTIONS. WITH ADJUSTABLE LOWER AND UPPER ACTUATION THRESHOLD.

### FUNCTIONING

The relay is designed to work with the current transformer with secondary current 5A. Transformer's primary circuit is included in the circuit being measured, and secondary to the terminals of the measuring relay. Potentiometers are set thresholds for current - the lower  $I_{min}$  and upper  $I_{max}$ . Excess over the measured intensity of the current closes the appropriate contacts in accordance with the desired work function. Contact closure is delayed setting potentiometers T1 (for contact R1) and T2 (for

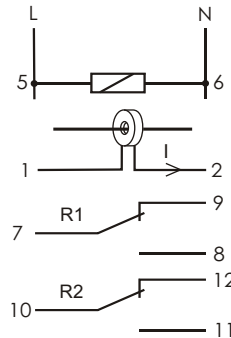

supply	230V AC
contact	2× separowany 1P
current load R1 i R2	2×[<16A]
input current measurement 1-2	<5A
current switch - adjustable	$I_{min}$ 0,02÷1A
	$I_{max}$ 0,5÷5A return
histeresis	10%
actuation time T1 i T2 - adjustable	0÷20sec
return time	0,5sec
power consumption	0,4W
working temperature	-25÷50°C
connection	screw terminals 2,5mm <sup>2</sup>
dimensions	3 modules (52,5mm)
fixing	on rail TH-35

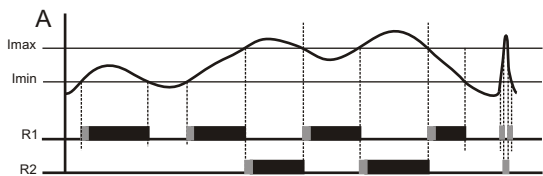

After crossing the  $I_{min}$ , contact R1 will close. After crossing the threshold of  $I_{max}$  contact R2 will close and R1 contact will be opened.

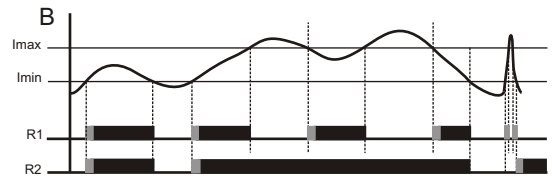

After crossing the  $I_{min}$  contacts R1 and R2 will close. After crossing the threshold of  $I_{max}$  R1 contact will open and R2 contact is closed.

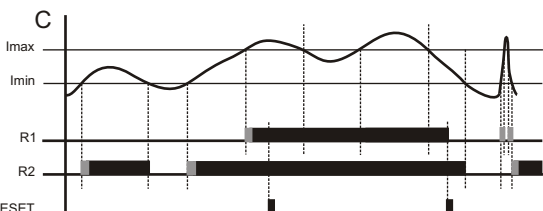

After crossing the  $I_{min}$  the R2 contact will be closed. After crossing the threshold of  $I_{max}$  the R1 contact will be closed. Contact R1 is locked until you press the RESET button. If value exceeding  $I_{max}$ , the R1 contact doesn't react to the RESET button.

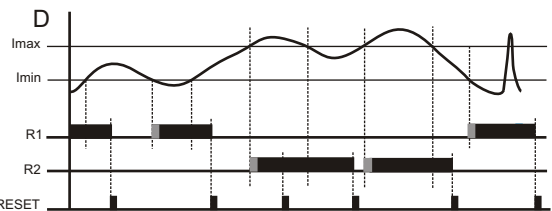

After crossing the  $I_{min}$  the R1 contact will be closed. After crossing the threshold of  $I_{max}$  the R2 contact will be and R1 contact is opened. Contact R1 and R2 are locked until you press the RESET button. If a value exceeding  $I_{max}$ , the contact R2 doesn't react to RESET.

# 19.

# FUSE MODULES

## PURPOSE

Fuse modules serve as a security device for electric receivers against current increase over the nominal current value for the secured receiver.

## FUNCTIONING

Fuse actuation (blowing of fuse link) is signalled by a red LED.

### BZ-1

One-socket.

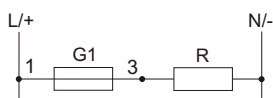

fuse link Ø5×20mm

### BZ-2

Two-socket.

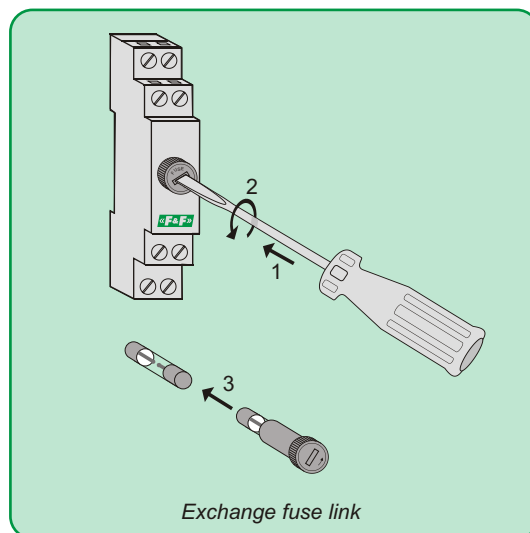
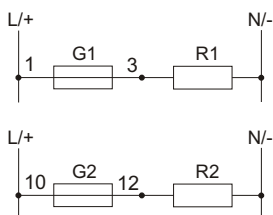

Exchange fuse link

### BZ-3

Three-socket.

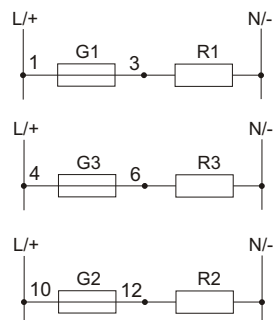

### BZ-4

Four-socket.

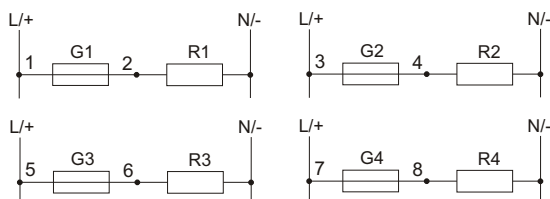

fuse	fuse link Ø5×20mm
voltage	250V AC
current	<6,3A
working temperature	-25+50°C
connection	screw terminals 2,5mm <sup>2</sup>
dimensions BZ-1, BZ-2, BZ-3	1 module (18mm)
BZ-4	2 modules (35mm)
fixing	on rail TH-35

## ATTENTION!

With DC power supply, proper polarity of the connection is of importance since otherwise the LED shall not signal the fuse actuation.

# 20. MICROPROCESSOR-BASED RELAY FOR ELECTRIC ENGINES

## EPS

### APPLICATION

The EPS is intended as a safety device for 3-phase electric motors. It is extremely efficient for expensive applications where reliability is essential, like for elevators, transporters, hoists, fans, centrifuges, compressors, etc.

### FUNCTIONING

The relay controls loads for all phases. Based on the values preset by the user, as well as the actual current consumed by the motor, the operation of the motor is analysed by the relay's CPU. By comparing the operation of the motor in question with model characteristics stored in the CPU, the device detects all defects very quickly and accurately, and immediately switches off the motor.

### SECURITY FEATURES

- THERMAL PROTECTION
- PROTECTION AGAINST MECHANICAL OVERLOAD
- PROTECTION AGAINST FAN STALL
- PROTECTION AGAINST FREQUENT RESTARTS
- PROTECTION AGAINST PHASE COLLAPSE
- PROTECTION AGAINST LOAD UNBALANCE
- PROTECTION AGAINST EARTH FAULT

### ADDITIONAL FEATURES

- INITIAL LIGHT SIGNALLING OF ENGINE OVERLOAD
- SELECTIVE SIGNALLING OF TRIP CAUSE
- REMOTE RELAY MOTOR CONTROL DIRECTLY FROM INDUSTRIAL CONTROLLERS
- MOTOR'S THERMAL MEMORY



The EPS is available in seven current versions: 5 A, 10 A, 16 A, 25 A, 45 A, 63 A, and 100 A. The actual working current set value range for each version is from 62 to 100% of the relay's rated current ( $0.625 \div 1 \times I_n$ ). Therefore, the selection of a proper relay depends on the power of the engine to be protected and its rated current. For engines with power between several hundred watts and 55 kW, the EPS with a proper set current range can be used, whereas more powerful units require the 5A EPS version with additional external current transformers.

EPS VERSION	SETTING RANGE
5A	3,125÷5A
10A	6,25÷10A
16A	10÷16A
25A	15,625÷25A
40A	25÷40A
63A	39,375÷63A
100A	62,5÷100A

to cooperatin with current transformer

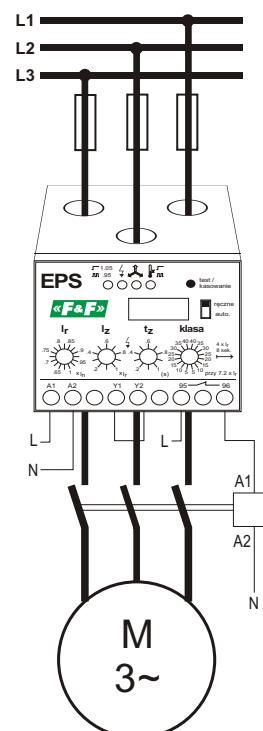
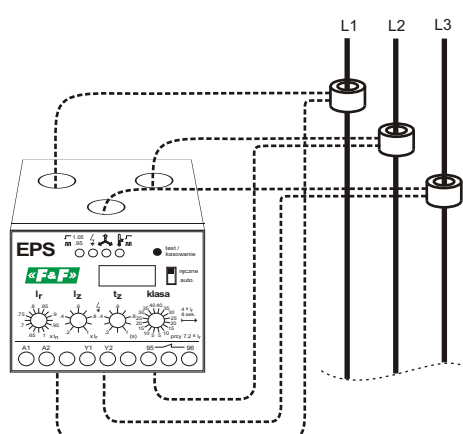

Power supply	230V AC
Main circuits' insulation voltage	690V~
Rated current (I <sub>n</sub> )	see label on EPS case
current load of contact	2A AC-15
Effective current unbalance	>30%
Delay at phase decay and unbalance	4sec.
Max. cable diameter	Ø14
Terminal	screw terminals 2,5 mm
Measurements	72×59×88 mm
Weight	385g
Fixing	on rail TH-35

# EPS-D

## APPLICATION

The EPS-D is intended as a safety device for 3-phase electric motors. It is extremely efficient for expensive applications where reliability is essential, like for pumps, hydrophores, elevators, transporters, hoists, fans, centrifuges, compressors, etc.

## FUNCTIONING

The relay controls loads for all phases. Based on the values preset by the user, as well as the actual current consumed by the motor, the operation of the motor is analysed by the relay's CPU. By comparing the operation of the motor in question with model characteristics stored in the CPU, the device detects all defects very quickly and accurately, and immediately switches off the motor.

## SECURITY FEATURES

- THERMAL PROTECTION
- PROTECTION AGAINST IDLE OPERATION AND DRY RUN (undercurrent protection)
- PROTECTION AGAINST MECHANICAL OVERLOAD
- PROTECTION AGAINST FAN STALL
- PROTECTION AGAINST FREQUENT RESTARTS
- PROTECTION AGAINST PHASE COLLAPSE
- PROTECTION AGAINST PHASE SEQUENCE SWITCH
- PROTECTION AGAINST LOAD UNBALANCE
- PROTECTION AGAINST EARTH FAULT

## OPTIONAL SECURITY FEATURES

AGAINST SHOCK (an additional Ferranti transformer enables efficient protection within the range of 30 mA 500 mA. Response time: approx. 100 ms).

## ADDITIONAL FEATURES

- MOTOR LOAD PREVIEW
- MESSAGE CONCERNING THE CAUSE OF PROTECTION ACTIVATION
- MOTOR'S THERMAL MEMORY



The relay's LCD screen shows an actual current value for a single, selected phase. This is available in absolute (A) or relative (%) values in relation to the set current value  $I_n$ . additionally, the device displays the scope of the measured current by means of characters ( $I > 105\% I_n$ ), ( $I < 95\% I_n$ ), ( $95\% I_n \leq I \leq 105\% I_n$ ). The relay measures the real current value up to and including the 7th harmonic. The measurement accuracy is 1%.

VERSION	SETTING RANGE	
20A	0+20A	to cooperatin with current transformer
20A	0+25A	
100A	20+100A	

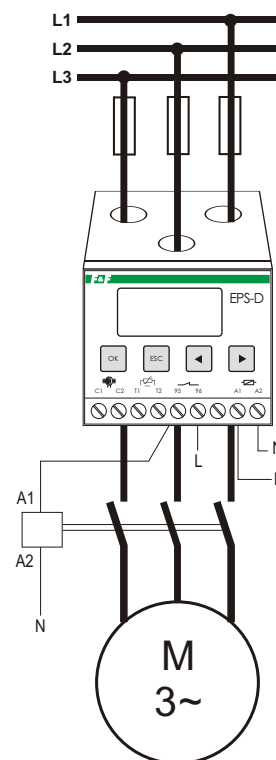
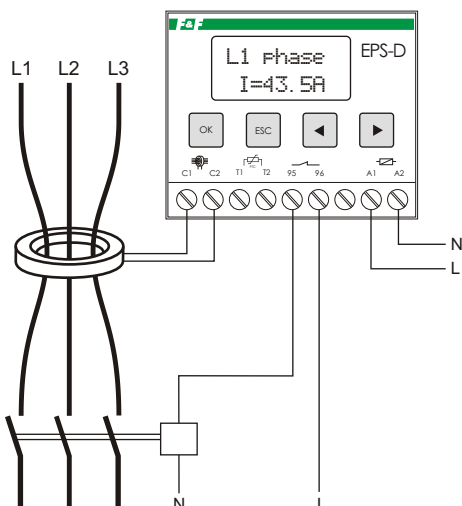

Power supply	230V AC
Main circuits' insulation voltage	690V~
Rated current ( $I_n$ )	see label on EPS case
current load of contact	2A AC-15
Effective current unbalance	>30%
Delay at phase decay and unbalance	4sec.
Max. cable diameter	Ø14
Terminal	screw terminals 2,5 mm
Measurements	72×59×88 mm
Weight	385g
Fixing	on rail TH-35

# 21. ELECTRIC SUPPLIERS AND TRANSFORMERS

## ZS 1÷6 TRANSFORMER-BASED 12W

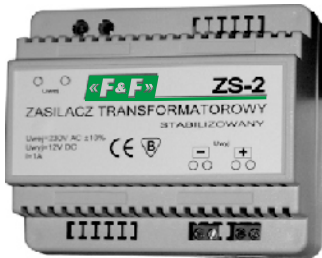

TYPE	OUTPUT VOLTAGE	OUTPUT CURRENT
ZS-1	5V DC	2A
ZS-2	12V DC	1A
ZS-3	18V DC	0,66A
ZS-4	24V DC	0,5A
ZS-5	15V DC	0,8A
ZS-6	48V DC	0,25A

input voltage	230 V ± 10% AC
output power	12W
current limitation	I max = 110% of output current
working temperature	-10+60°C
current ripple	<3mV RMS
connection	screw terminals 2,5mm <sup>2</sup>
dimensions	6 modules (105mm)
weight	550g
fixing	on the TH-35 rail

## ZI-21 IMPULSOWY 12W



TYPE	OUTPUT VOLTAGE	OUTPUT CURRENT
ZI-21	24V DC	0,5A

input voltage	85+264V AC
output power	12W
current limitation	I max = 110% of output current
working temperature	-10+60°C
minimum load	0%
keying frequency	70 kHz
connection	screw terminals 2,5mm <sup>2</sup>
dimensions	1 module (18mm)
weight	80g
fixing	on the TH-35 rail

## ZI 1÷6 PULSE 50W



TYPE	OUTPUT VOLTAGE	OUTPUT CURRENT
ZI-1	5V DC	10A
ZI-2	12V DC	4A
ZI-3	18V DC	3A
ZI-4	24V DC	2A
ZI-5	15V DC	3,3A
ZI-6	48V DC	1A

input voltage	85+264V AC
output power	50W
current limitation	I max = 110% of output current
working temperature	-10+60°C
minimum load	0%
keying frequency	70 kHz
connection	screw terminals 2,5mm <sup>2</sup>
dimensions	6 modules (105mm)
weight	550g
fixing	on the TH-35 rail

## ZI-22-24 PULSE 30W



TYPE	OUTPUT VOLTAGE	OUTPUT CURRENT
ZI-22	12V DC	2,5A
ZI-24	24V DC	1,25A

input voltage	100+264V AC
output power	30W
current limitation	I max = 110% of output current
working temperature	-10+40°C
minimum load	0%
keying frequency	70 kHz
connection	screw terminals 2,5mm <sup>2</sup>
dimensions	3 modules (52,5mm)
weight	190g
fixing	on the TH-35 rail

## ZT 1÷6 TRANSFORMER-BASED WITH PULSE STABILIZER



TYPE	OUTPUT VOLTAGE	OUTPUT CURRENT
ZT-1	5V DC	3A
ZT-2	12V DC	2A
ZT-4	24V DC	1A

input voltage	180+264V AC
output power	25W
current limitation	I max = 110% of output current
working temperature	-10+40°C
minimum load	0%
keying frequency	52 kHz
connection	screw terminals 2,5mm <sup>2</sup>
dimensions	6 modules (105mm)
weight	742g
fixing	on the TH-35 rail



## ZI 11÷14 PULSE STABILIZER



TYPE	INPUT VOLTAGE	OUTPUT VOLTAGE	OUTPUT CURRENT
ZI-11	8÷28V AC / 12÷37V DC	5V DC	3A
ZI-12	12÷28V AC / 16÷37V DC	12V DC	3A
ZI-13	18÷28V AC / 22÷37V DC	18V DC	3A
ZI-14	24÷28V AC / 38÷27V DC	24V DC	3A

input voltage	10÷28V AC
output current	3A
current limitation	I max = 110% of output current
minimum load	0%
working temperature	-10÷60°C
connection	screw terminals 2,5mm <sup>2</sup>
dimensions	3 modules (52,5mm)
weight	150g
fixing	on the TH-35 rail

## ZI-60-24 / ZI-120-24 / ZI-240-24 PULSE POWER INDUSTRY



supply	90÷264VAC/120÷370VDC
output voltage	24V DC
frequency	47÷63Hz
min. load	0%
switching frequency	
breakdown voltage IN->OUT	3kV
overload	105%/3min
cooling	air gravity
protection	Short circuit / overload overvoltage / temperature
supply indication	green LED
overload/surge indication	red LED
working temperature	-10÷70°C
fixing	on the rail TH-35

type	power [W]	current [A]	output regul. [V]	efficiency [%]	dimensions [mm]	weight [g]
ZI-60-24	60	2,5	22÷27V	84	130×50×90	485
ZI-120-24	120	5,0	22÷28V	87	130×75×90	630
ZI-240-24	240	10,0	22÷28V	86	130×110×90	1040

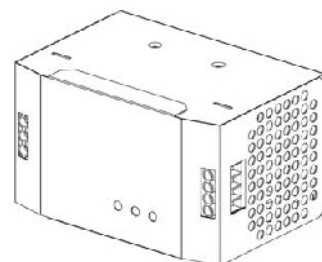

## TR-08 / TR-12 / TR-24 MAINS TRANSFORMER

### PURPOSE

Application: power supply of electrical and electronic devices which do not require a stable and properly filtered supply voltage, regardless of mains voltage fluctuations.



supply	230V AC
efficiency	85%
working temperature	-10÷45°C
dimensions	TR-08 2 modules (35mm)
	TR-12 3 modules (52,5mm)
	TR-24 3 modules (52,5mm)
weight	TR-08 271g
	TR-12 325g
	TR-24 433g
connection	screw terminals 2,5mm <sup>2</sup>
fixing	on rail TH-35

TYP	OUT SUPPLY.	CURRENT	POWER
TR-08	8V	1A	8VA
TR-12	12V	0,66A	8VA
TR-24	24V	0,5A	12VA

The transformer system has an incorporated PTC posistor which offers overcurrent protection.

# 22.

# POWER SUPPLY INDICATORS

## SIGNAL LAMPS

### LK-712 One phase.

#### PURPOSE

Designed to optically signal the presence of voltage in a electrical circuit.

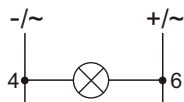

TYPE	COLOURS OF LED
LK-712 G	1×GREEN
LK-712 Y	1×YELLOW
LK-712 R	1×RED
LK-712 B	1×BLUE

supply (made in one range only)	5÷10V AC/DC
	10÷30V AC/DC
	30÷130V AC/DC
	130÷260V AC/DC
voltage indicator	1×LED
power consumption	0,8W
connection	screw terminals 2,5mm <sup>2</sup>
working temperature	-25÷50°C
dimensions	1 module(18mm)
fixing	on rail TH-35

Order labelling method: LK-712 B 30÷130V — supply voltage colour of LED

### LK-713 Three phases.

#### PURPOSE

Designed to optically signal the presence of voltage in the three-phase electrical network. The presence of voltage in a phase is signalled by the green LED in the circuit of each phase.

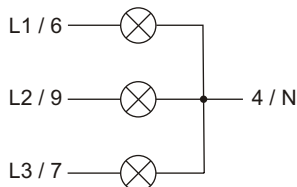

TYPE	COLOURS OF LED
LK-713 G	3×green LED
LK-713 Y	3×yellow LED
LK-713 R	3×red LED
LK-713 K	yellow-red-green LEDs

supply	3×230V+N
voltage indicator	3×LED
power consumption	1,1W
connection	screw terminals 2,5mm <sup>2</sup>
working temperature	-25÷50°C
dimensions	1 module (18mm)
fixing	on rail TH-35

Order labelling method: LK-713 K — colour of LEDs

### LK-714 Two ability type.

#### PURPOSE

Designed to optically signal the ability of recivers, for example: work - break, opened - closed, ect. It has two separated signal circuit: green LED and red LED.

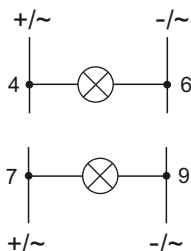

supply (made in one range only)	5÷10V AC/DC
	10÷30V AC/DC
	300÷130V AC/DC
	13÷260V AC/DC
indicator	1×LED green
	1×LED red
power consumption	1,6W
connection	screw terminals 2,5mm <sup>2</sup>
working temperature	-25÷50°C
dimensions	1 module(18mm)
fixing	on rail TH-35

Order labelling method: LK-714 30÷130V — supply voltage

## VOLTAGE INDICATORS

### PURPOSE

Voltage indicators are devised to continually measure the value of the voltage in a single-phase or three-phase network.

### LED LINE TYPE

**WN-711** One phase indicator.

**WN-723** Three phase indicator.

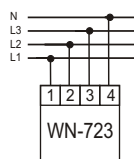
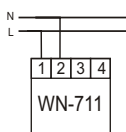

supply	WN-711	230V AC
	WN-723	3×400V+N
voltage indicator	WN-711	11×LED
	WN-723	3×(11xLED)
indication range		205+245V
scale		5V
indication precision		2,5V
power consumption		0,8W
connection		screw terminals 2,5mm <sup>2</sup>
working temperature		-25+50°C
dimensions	WN-711	1 modul (17,5mm)
	WN-723	2 moduly (35mm)
fixing		on rail TH-35

### DIGITAL

**DMV-1** **DMV-1 TrueRMS** One phase indicator.

**DMV-3** **DMV-3 TrueRMS** Three phase indicator.

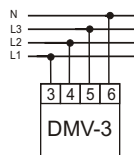
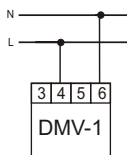

supply		100+300V AC
frequency		45+55Hz
indication range		100+300V
indication precision		
	DMV-1; DMV-3	1%
	DMV-1 True RMS; DMV-3 True RMS	0,5%
display for one phase		3×segment LED 10×6mm
power consumption		4W
working temperature		-25+50°C
connection		screw terminals 2,5mm <sup>2</sup>
dimensions		3 moduly (52,5mm)
fixing		on rail TH-35

\* phase voltage measurement

\* measuring circuit is also a device supplying circuit

\* indicators with True RMS marking, equipped with RMS value converter, give proper voltage value for deflected runs

### DIGITAL

**DMV-1T** One phase indicator.

**DMV-3T** Three phase indicator.

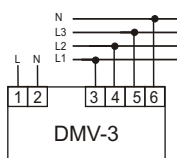
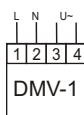

supply		230V AC
indication range	DMV-1T	12+600V
	DMV-3T	3×0+400V
indication precision		1%
display		
	DMV-1T	4×segment LED 14×8mm
	DMV-3T	3×(4×segment LED 14×8mm)
power consumption		3VA
working temperature		-5+50°C
connection		screw terminals 2,5mm <sup>2</sup>
dimensions		
	DMV-1T	72×72×92mm
	DMV-3T	96×96×92mm
fixing hole		
	DMV-1T	66×66mm
	DMV-3T	92×92mm

# CURRENT INTENSITY INDICATORS

## PURPOSE

Current intensity indicators are devised to continually measure the value of the current in a circuits of single-phase or three-phase network.

## DIGITAL

**DMA-1** **DMA-1 True RMS** One phase indicator.

**DMA-3** **DMA-3 True RMS** Three phase indicator.

\* independent current measurement for each phase

\* indicators with True RMS marking, equipped with RMS value converter, give proper voltage value for deflected runs

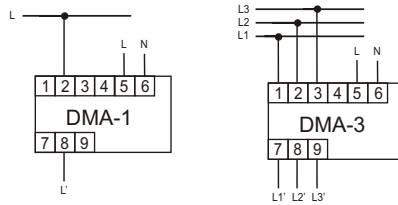

supply	100÷300V AC
frequency	45÷55Hz
max. measured current	20A
max. temporary overloading of current	40A (<1sec)
indication precision	
DMV-1; DMV-3	1%
DMV-1 True RMS; DMV-3 True RMS	0,5%
display for one phase	3×segment LED 10×6mm
power consumption	4W
working temperature	-25÷50°C
connection	screw terminals 2,5mm <sup>2</sup>
dimensions	3 moduly (52,5mm)
fixing	on rail TH-35

DMA indicators are intended for current transformers with a rated secondary current of 5A. The current range for these transformers is from 25 to 1000/5A. The primary value of the transformer's current specifies the maximum measured current and the actual current value displayed by the indicator.

The DMA-20A and DMA-3 20A are intended for direct measurements (without transformers applied) within the range of 0÷20A.

Order labelling method:

INDIRECT MEASUREMENT (with transformers applied)

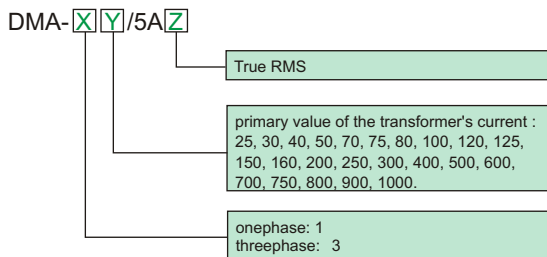

Example:  
 \* DMA-150/5A a one-phase device for 50/5A transformer, measurement range at 0÷50A, no TrueRMS;  
 \* DMA-3150/5 A TrueRMS a three-phase for 3×150/5A transformers, measurement range at 3 ×0÷150A, incl. TrueRMS.

DIRECT MEASUREMENT (without transformers)

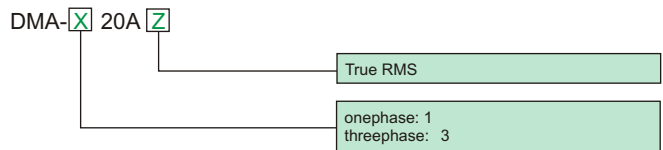

Przykład:  
 \* DMA-1 20A - jednofazowy do 20A, zakres mierzony 0÷20A, bez TrueRMS  
 \* DMA-3 20A TrueRMS - trójfazowy do 20A, zakres mierzony 3x0÷20A, z TrueRMS

**DMA-1T** One phase indicator.

**DMA-3T** Three phase indicator.

\* direct measurement 0÷5A

\* indirect measurement using current transformers

\* setting indicator to proper current transformer values using three buttons on the indicator's front

\* indirect measurement using current transformers in standard current work with 1÷9000/5A range.

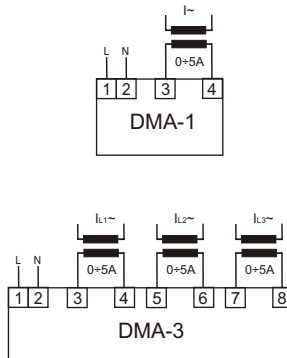

supply	230V AC
max. current of direct measure for single phase	5A
max. current of indirect measure	dependent on applied current transformer
possible type of current transformer to connect	1÷9000/5A
indication precision	1%
display	
DMA-1T	4×segment LED 14×8mm
DMA-3T	3×(4×segment LED 14×8mm)
power consumption	3VA
working temperature	-5÷50°C
connection	screw terminals 2,5mm <sup>2</sup>
dimensions	
DMA-1T	72×72×92mm
DMA-3T	96×96×92mm
fixing hole	
DMV-1T	66×66mm
DMV-3T	92×92mm

# MULTIMETERS

## PURPOSE

Multimeters are intended for monitoring parameters of three-phase electrical network.

### DMM-1T ONE-PHASE TYPE

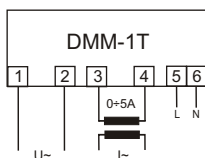

- \* independent current measurement for each phase
- \* direct measurement 0+5A
- \* indirect measurement using current transformers in standard current work with 1+9000/5A range
- \* setting indicator to proper current transformer values using three buttons on the indicator's front
- \* phase voltage and phase to phase voltage measurement
- \* phase frequency measurement

supply	230V AC
max. current of direct measure for single phase	5A
max. current of indirect measure	depended on applied current transformer
possible type of current transformer to connect	1+9000/5A
measured frequency range	10+100Hz
measured voltage range	0+400V
indication precision	1%±1 digit
display	4×segment LED 5×9mm
power consumption	3VA
working temperature	-5+50°C
connection	screw terminals 2,5mm <sup>2</sup>
dimensions	96×96×92mm
fixing hole	92×92mm

### DMM-4T THREE-PHASE TYPE

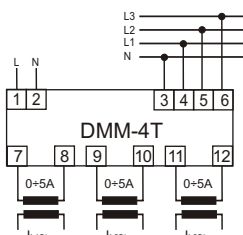

- \* independent current measurement for each phase
- \* direct measurement 0+5A
- \* indirect measurement using current transformers in standard current work with 1+9000/5A range
- \* setting indicator to proper current transformer values using three buttons on the indicator's front
- \* phase voltage and phase to phase voltage measurement
- \* phase frequency measurement
- \* selection of indicated voltage and frequency values for a single phase using button on indicator's front

supply	230V AC
max. current of direct measure for single phase	5A
max. current of indirect measure	depended on applied current transformer
possible type of current transformer to connect	1+9000/5A
measured frequency range	10+100Hz
measured voltage range	0+400V
indication precision	1%±1 digit
display	4×segment LED 5×9mm
power consumption	3VA
working temperature	-5+50°C
connection	screw terminals 2,5mm <sup>2</sup>
dimensions	96×96×92mm
fixing hole	92×92mm

### DMM-3T THREE-PHASE TYPE

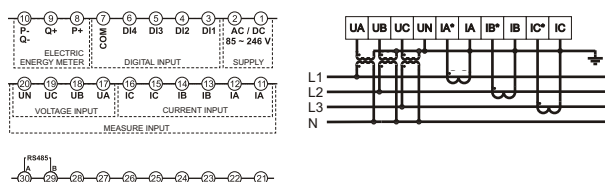

- \* direct or indirect (using current transformer) measurement of phase currents.
- \* direct or indirect (using current transformer) measurement of phase voltage and phase to phase voltage.
- \* frequency measurement
- \* active, wattless and apparent power measurement
- \* power factor measurement
- \* four-quadrant measurement of input and output energy
- \* constant or periodical display of one of eight measured values, automatic switching between the displayed values
- \* digital inputs
- \* OC type pulse output (open collector)
- \* communication with peripheral devices using RS485 interface and MODBUS RTU protocol (up to 32 devices)

supply	85+264V AC/DC
power consumption	<5VA
frequency	45+65Hz
operation temperature	-10+50°C
humidity (free of wet and gascorruption)	≤85%
elevation	≤3000m n.p.m.
dimansion	96×96×105mm
fix hole	92×92mm
network	three phase three-wire or four-wire
measuringaccuracy	
voltage/current	±(0,5%FS + 1 digit)
power	±(0,5%FS + 1 digit)
frequency	±0,1Hz
power factor	±0,01
active electric energy	±0,5%
reactive electric energy	±2%
digital output	
ways	4
signal	non current type
electric energy meter	
output mode	two-channel open collector optical pulse output
puls constant - active	10000imp/kWh
- reactive	10000imp/kVARh
communication	
output mode	RS 485
protocol	MODBUS RTU
baud rate	4880bps
working temperature	-5+50°C
connection	screw terminals 2,5mm <sup>2</sup>
dimensions	96×96×92mm
fixing hole	92×92mm

**ELECTRIC ENERGY METERS**

**PURPOSE**

LE are a static (electronic) rated electric energy meters which are to serves as an auxiliary meters to measure the energy consumption in a direct system.

**FUNCTIONING**

The meter is equipped with a special electronic circuit which generates pulses proportionally to electric energy consumption in a given phase by means of the current flow and voltage applied. The sum of the pulses from *t* is signalled by blinking of an LED, calculated in phase into the electric energy consumed in the system, and finally its total value is indicated by a mechanical drum counter. For LE-01 and LE-03 the last red digit in the counter indicates 0.1 KWh (100 Wh), 1/10 KWh (100Wh).

**DIRECT MEASUREMENT TYPE**

**LE-01 / LE-01d SINGLE-PHASE**

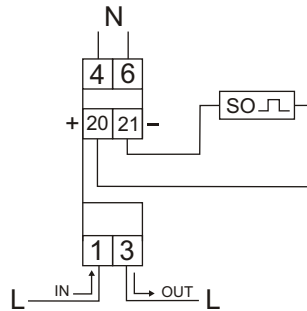

reference voltage	230V AC ±30%
basic current	5A
maximum current	45A
minimum current	0,02A
measurement accuracy per IEC61036	class 1
counter's own power consumption	<8VA; <0,4W
drum counter indication range	
LE-01	0+99999.9 kWh
LE-01d	0+99999.99 kWh
constant of a meter (1Wh/pulse)	1000 pulses/kWh
current consumption signal	1×red LED
pulse output SO+ SO-	open collector
connection voltage SO+ SO-	< 27V DC
connection current SO+ SO-	< 27mA
constant SO+ SO- (1Wh/pulse)	1000 pulses/kWh
czas impulsu SO+ SO-	90msek
working temperature LE-01	-20+65°C
LE-01d	-20+50°C
protection level	IP20
connection	6mm <sup>2</sup> screw terminals
measurements	1 modules (18 mm)
fixing	on rail TH-35

**LE-02d THREE-PHASE**

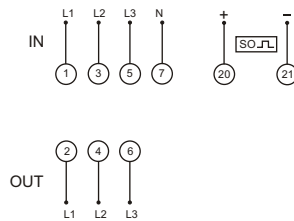

reference voltage	3×230/400V+N
basic current	5 A
maximum current	63A
minimum current	0,04A
measurement accuracy per IEC61036	class 1
counter's own power consumption	<10VA; <2W
drum counter indication range	0+999999.99 kWh
constant of a meter (1,25 Wh/pulse)	800 pulses/kWh
current consumption signal	3×red LEDs
read-out status signal	red LED
pulse output SO+ SO-	open collector
connection voltage SO+ SO-	< 30V DC
connection current SO+ SO-	< 27mA
constant SO+ SO- (1.25 Wh/pulse)	800 pulses/kWh
working temperature	-20+50°C
protection level	IP20
connection	16mm <sup>2</sup> screw terminals
measurements	4,5 modules (75 mm)
fixing	on rail TH-35

**LE-03 / LE-03d THREE-PHASE TYPE**

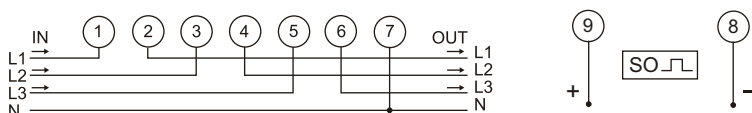

reference voltage	3×230/400V+N
basic current	10 A
maximum current	100A
minimum current	0,04A
measurement accuracy per IEC61036	class 1
counter's own power consumption	<10VA; <2W
drum counter indication range	0+999999.9 kWh
constant of a meter (1,25 Wh/pulse)	800 pulses/kWh
current consumption signal	3×red LEDs
read-out status signal	red LED
pulse output SO+ SO-	open collector
connection voltage SO+ SO-	< 30V DC
connection current SO+ SO-	< 27mA
constant SO+ SO- (1.25 Wh/pulse)	800 pulses/kWh
working temperature LE-03	-20+65°C
LE-03d	-20+50°C
protection level	IP20
connection	25mm <sup>2</sup> screw terminals
measurements	7 modules (122 mm)

# TO CO-OPERATION WITH A CURRENT TRANSFORMERS

## PURPOSE

These meters are intended for current transformers with a secondary current of 5A. Maximum measured current of the system is specified by the value of the primary current while using the current transformer.

**Current transformers - see the chapter 28.**

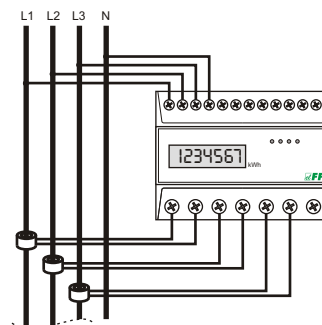

## WITH PROGRAMMABLE CURRENT TRANSDUCER RATIO LE-02d CT THREE-PHASE TYPE

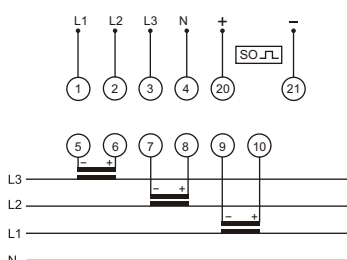

reference voltage	3×230/400V+N
basic current	3×1,5A
max current	3×6A
secondary current	5A
min current	0,04A
measure precision with IEC61036	class 1
meter's own power consumption	<10VA; <2W
number of LCD signs	8
range of display reports	dependent on transmission
constant of the meter	12000imp/kWh
current consumption signal	3×LED red
meter signal	LED red
impulse output SO+ SO-	open collector
connection voltage SO+ SO-	<30V DC
connection current SO+ SO-	<27mA
constant SO+ SO-	dependent on transmission
working temperature	-20+55°C
protection level	IP20
connection	screw terminals 25mm <sup>2</sup>
dimensions	4,5 modules (75mm)
fixing	on the rail TH-35

## FUNCTIONING

The user has the ability to set the index value used gear ratio, which allows you to indicate the actual value taken by the electricity system.

In the memory of indicator are preserved values of primary currents  $I_p$  transformers feasible. Choosing the appropriate value in accordance to the values of the connected transformers automatically sets the appropriate factor, according to which computes the actual value of the electricity taken. The LCD displays the actual value of the energy collected in a format depending on the selected gear.

CT currents  $I_p$  inscribed in memory of the indicator:

5, 20, 30, 40, 50, 60, 75, 80, 100, 120, 150, 200, 250, 300, 400, 500, 600, 750, 800, 1000, 1200, 1250, 1500, 2000, 2500, 3000, 4000, 5000, 6000.



przycisk programowania

## LE-03d CT200 / LE-03d CT400

### TO CO-OPERATION WITH A DEDICATED CURRENT TRANSFORMERS

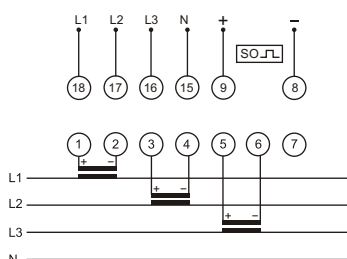

type of transformer	LE-03d CT200	200/5A
	LE-03d CT400	400/5A
reference voltage	3×230/400V+N	
basic current	3×1,5 A	
maximum current	3×5A	
minimum current	0,04A	
measurement accuracy per IEC61036	class 1	
counter's own power consumption	<10VA; <2W	
drum counter indication range	0+999999,9 kWh	
constant of a meter	(0,083Wh/imp)	12000imp/kWh
current consumption signal	3×red LEDs	
read-out status signal	red LED	
pulse output SO+ SO-	open collector	
connection voltage SO+ SO-	< 30V DC	
connection current SO+ SO-	< 27mA	
constant SO+ SO-	(0,083Wh/imp)	12000imp/kWh
working temperature	-20+55°C	
protection level	IP20	
connection	25mm <sup>2</sup> screw terminals	
measurements	7 modules (122 mm)	
fixing	on rail TH-35	

In the case of transformers with dedicated operating parameters, the meters display the actual value of the power consumed by the system.

## TWO-TARIFFS TYPE

### LE-04d

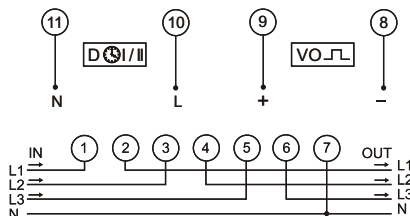

reference voltage	3×230/400V+N
basic current	10A
max current	100A
min current	0,04A
measure precision with IEC61036	class 1
meter's own power consumption	<10VA; <2W
range of display reports T0 i T1	0+99999,99kWh
constant of the meter	(1,25Wh/imp) 800imp/kWh
current consumption signal	4×LED red
meter signal T0 i T1	2×LED red
impulse output VO	open collector
connection voltage VO	<24V DC
connection current SO+ SO-	<30mA
constant VO	(1,25Wh/imp) 800imp/kWh
working temperature	-20+55°C
protection level	IP20
connection	screw terminals 25mm <sup>2</sup>
dimensions	7 modules (122mm)
fixing	on the rail TH-35

The counter is equipped to measure the electricity in two tariff system. The values indicated in the power tariffs are separate displays T0 and T1. Switching between the tariffs is fed to the input control voltage meter D (joints 10-11). This can be used for controlling the external clock. Counter T0 read energy input in the absence of voltage control at the entry to the T1 D. Meter read energy input from the control voltage appears at the entrance to the D decay. Operation of the meter is indicated by shine the corresponding LED.

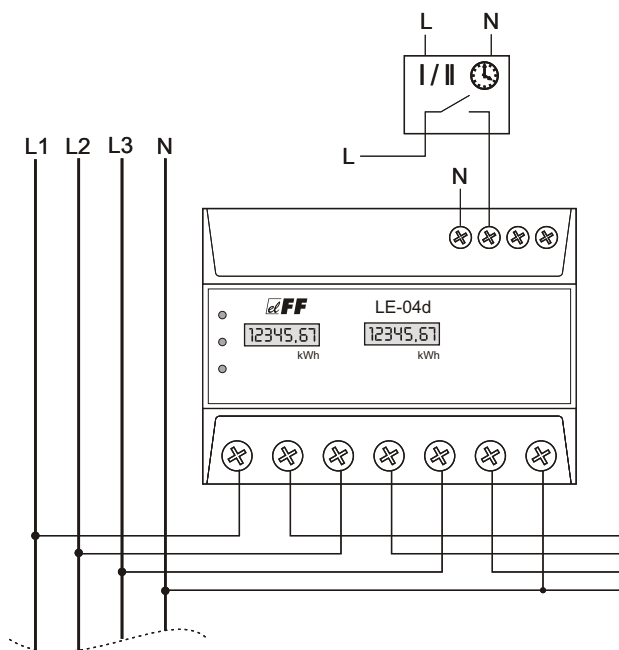

## Pulse output supply system with connected external counting machine

### FUNCTIONING

In order to connect to electricity energy meter counting device has to be connected in parallel to the system power supply 12±24V DC through resistor 3.6 ÷ 8.2 kOhm / 0,5 W current limiting. Maximum load counting circuit is 27mA.

### ATTENTION!

Changing the polarization of power can damage the meter pulse output.

### ATTENTION!

In the absence of connecting an external counting device is not allowed to connected to the output pulse power system.

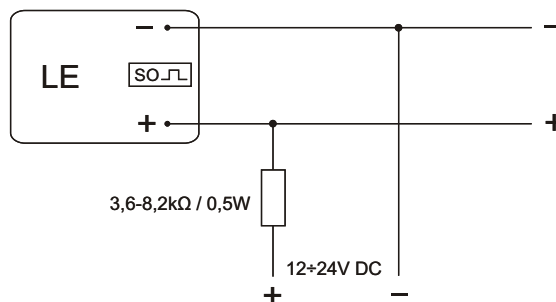



# WITH RS-485 PORT AND MODBUS RTU COMMUNICATION PROTOCOL

## PURPOSE

Energy meters M. series are used for reading and recording taken of electricity with possibility of remote readings of energy meters registers group via wired network in RS-485 standard.



## FUNCTIONING

Communication with energy meters as a slave device is in compliance with the standard Modbus RTU via RS-485. The indication is written in the form of consecutive bytes of hex. When converted to decimal form we obtain the result in kWh consistent with the indications on the display counter.

### LE-01M SINGLE-PHASE TYPE

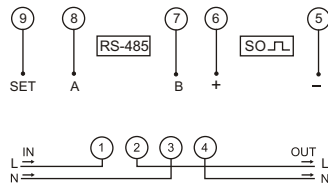

reference voltage	230V AC ±30%
basic current	10 A
maximum current	100A
minimum current	0,04A
measurement accuracy per IEC61036	class 1
counter's own power consumption	<10VA; <2W
drum counter indication range	0+99999,99 kWh
constant of a meter(0,625Wh/pulse)	1600 pulses/kWh
read-out status signal	red LED
pulse output SO+ SO-	open collector
connection voltage SO+ SO-	< 30V DC
connection current SO+ SO-	< 27mA
constant SO+ SO-(0,625 Wh/pulse)	1600 pulses/kWh
port	RS-485communication
ation protokol	MODBUS RTU
working temperature	-20+50°C
protection level	IP20
connection	25mm <sup>2</sup> screw terminals
measurements	4,5 modules (75 mm)
fixing	on rail TH-35

### LE-03M THREE-PHASE TYPE

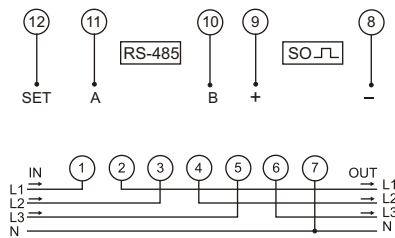

reference voltage	3×230/400V+N
basic current	3×10A
maximum current	3×100A
minimum current	0,04A
measurement accuracy per IEC61036	class 1
counter's own power consumption	<10VA; <2W
drum counter indication range	0+999999,9 kWh
constant of a meter (1,25Wh/pulse)	800 pulses/kWh
read-out status signal	red LED
pulse output SO+ SO-	open collector
connection voltage SO+ SO-	< 30V DC
connection current SO+ SO-	< 27mA
constant SO+ SO- (1,25Wh/pulse)	800 pulses/kWh
port	RS-485communication
ation protokol	MODBUS RTU
working temperature	-20+50°C
protection level	IP20
connection	25mm <sup>2</sup> screw terminals
measurements	7 modules (122mm)
fixing	on rail TH-35

### LE-03M CT WITH PROGRAMMABLE CURRENT TRANSDUCER RATIO

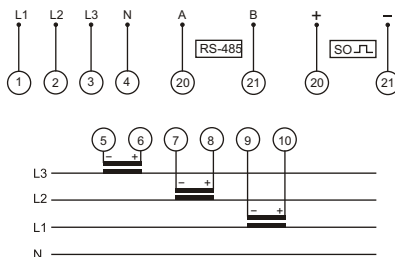

reference voltage	3×230/400V+N
basic current	3×1,5A
max current	3×5A
second current	5A
min current	0,04A
measure precision with IEC61036	class 1
meter's own power consumption	<10VA; <2W
range of display reports	dependent on transform
constaint of the meter (for 5/5A)	1200pulses/kWh
current consumption signaling	3×red LED
reading signaling	red LED
pulse output SO+ SO-	open collector
connection voltage SO+ SO-	<30V DC
connection current SO+ SO-	<27mA
constant SO+ SO-	dependent on transform
port	RS-485
ommunication protokol	MODBUS RTU
working temperature	-20+55°C
protection level	IP20
connection	screw terminals 25mm <sup>2</sup>
dimensions	7 modules (122mm)
fixing	on the rail TH-35

In the memory index values are preserved primary currents  $I_p$  transformers feasible. Choosing the appropriate value in accordance with the values of the connected transformers automatically sets the appropriate factor, according to which computes the actual value of the electricity taken. This value is projected on the LCD display format depending on the selected gear.

## PULSE METER

### PURPOSE

Pulse meters are intended for counting AC/DC voltage signals, generated by additional peripheral devices in order to determine the number of carried out working cycles in automatics systems, e.g. in order to control the number of press strokes, the number of revolutions of a rotating device, the number of components leaving the production line, etc.

## CLI-11T

### FUNCTIONING

CLI-11T meter is a one-way meter, enabling the counting of pulses from 0 to 999999 range (six digits). It is equipped with RESET input for the connection of an external button, enabling the resetting of the meter state for any value.

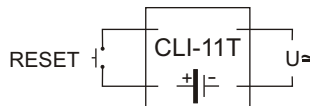

Supply	(non-voltage type) internal battery
Battery life	10 years
T input voltage	
CLI-11T 230V	110+240V AC/DC
CLI-11T 24V	4+30V DC
maximum counting frequency	200Hz
RESET input	non-voltage type
display	8 characters / h 6.7mm
precision	1%±1digit
connection	screw terminals 1,5mm <sup>2</sup>
working temperature	-5+50°C
dimensions	96×96×92mm
fixing hole	92×92mm

## CLI-01 PROGRAMMABLE

## CLI-02

### FUNCTIONING

CLI-01 is a programmable, one-way type electronic meter enabling the counting of external pulses in 0 to 99 999 999 range. Pulses are counted from 0 to value set by the user. After reaching the limiting value, the meter will stop to count. Meter will count from 0 again after reset.

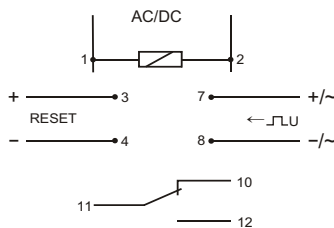

supply	24+264V AC/DC
T input voltage low state	0+4V
T input voltage high state	5+264V
RESET input voltage	24+264V
maximum frequency for DC signal	5kHz
maximum frequency for AC signal	50Hz
maximum relay load current	8A
power input	1,5W
operating temperature	-20+50°C
terminal	screw terminal 2,5mm <sup>2</sup>
dimensions	3 modules (52,5mm)
assembly	TH-35 bus

### FUNCTIONS

- \* control panel, enabling programming and the monitoring of device operation
- \* T input, adapted for operation with AC/DC signal, 5 to 264V amplitude and 50 Hz frequency for AC and 5kHz for DC signals
- \* possibility to set THRESHOLD parameter (1÷99 999 999 range), specifying the limiting number of pulses counted in a single operation cycle
- \* external RESET input
- \* relay output signaling the preset meter state (contact 1C/O 8A)
- \* local counter, reset using the external reset input or using RESET button
- \* total counter for all impulses (loop mode 0 → 99 999 999 → 0 → ... or reset using the meter configuration menu)
- \* digital filter, enabling the limiting of maximum frequency of the counted pulses (in order to reduce interferences on meter input)
- \* local and total meter state memory after supply failure
- \* program menu in three languages: Polish, English or Russian

### ADDITIONAL FUNCTIONS OF CLI-02:

- \* 'downward' counting mode to the selected value with zero value signaling (e.g. 9999 → 0)
- \* selection of input pulse edge (leading or trailing) the counter will react to
- \* possibility of automatic local counter reset (loop mode) with possibility to set selected relay action
- \* relay action selection: pulse with set time length; ON OFF or OFF ON state change
- \* scaling pulse values according to set multiplier or divider
- \* limiting access to program menu using PIN code

## WORKING TIME METERS

### PURPOSE

Working time meters are intended for counting the number of working hours in automatic production processes or the number of device working hours, which, due to safety requirements and operation efficiency have limited overhaul life, i.e. operational capacity that may not be exceeded (e.g. advanced power units, special radioactive lamps, etc.).

### CLG-13T with button RESET CLG-14T without button RESET

### FUNCTIONING

CLG-13T meter is an electronic, one-way meter, enabling the counting of working hours in 0 to 99999,9 range (five digits + one decimal). It is equipped with RESET input for the connection of external button and RESET button in front (with locking), enabling counter state reset for any value.

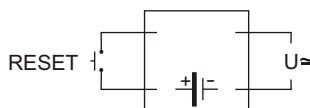

Supply	(non-voltage type) internal battery
Battery life	10 years
T input voltage	
CLG-11T 230V	110÷240V AC/DC
CLG-11T 24V	4÷30V DC
CLG-14T 230V	110÷240V AC/DC
maximum counting frequency	200Hz
RESET input	non-voltage type
display	6 characters / h 6.7mm
precision	1%±1 digit
connection	screw terminals 1,5mm <sup>2</sup>
working temperature	-5÷50°C
dimensions	96×96×92mm
fixing hole	92×92mm

## CLG-03

### FUNCTIONING

CLG-03 is a programmable, multi-function electronic meter, enabling the counting of working hours of the connected devices or systems in 1 to 999 999 range, corresponding to 114 years of operation. Working time is counted according to an individual program, set by the user. After reaching the limiting value, the meter will configure itself according to individual user's needs.

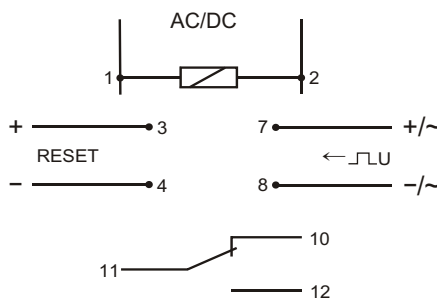
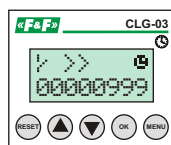

zasilanie	24÷264V AC/DC
napięcie wejścia zliczającego	4÷264V
prąd obciążenia przekaźnika	8A
pobór mocy	1,5W
temperatura pracy	-20÷50°C
przyłącze	zaciski śrubowe 2,5mm <sup>2</sup>
wymiary	3 moduły (52,5mm)
montaż	na szynie TH-35

### FUNCTIONS

- \* control panel, enabling programming and the monitoring of device operation
- \* T input for DC signal and AC signal 50 Hz
- \* counting time upwards without threshold value
- \* 'downward' counting mode to the selected value with zero value signaling (e.g. 9999 → 0)
- \* counting working time with high state (constant voltage) at the T input
- \* counting working time between two pulses given at the T input
- \* counting time upwards to the selected threshold value
- \* external RESET input
- \* relay output signaling the preset meter state (contact 1C/O 8A)
- \* relay action selection: pulse with set time length; ON → OFF or OFF → ON state change
- \* local and total meter state memory after supply failure
- \* limiting access to program menu using PIN code
- \* setting display illumination mode
- \* program menu in three languages: Polish, English or Russian

# 24. FLUID LEVEL CONTROL RELAYS

## PURPOSE

Fluid level control relays are used to detect the presence of fluid conductive the current on the level of mounted flooding sensors

## ONE-POSITION

### PZ-828 / PZ-828 RC ADJUSTABLE SENSITIVITY

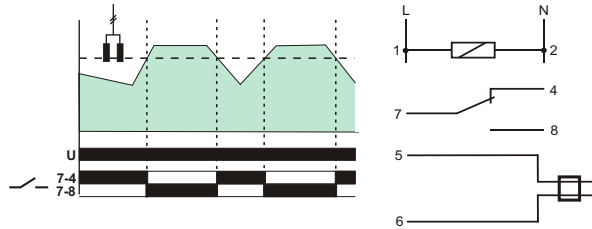

supply	230V AC
current load	<16A
contact	1 C/O
sensitivity	PZ-828 (factory setting) 50KΩ
	PZ-828 RC (adjustable) 4,5÷220KΩ
power supply indicator	green LED
working mode indicator	red LED
power consumption	1,1 W
terminal	screw terminals 2,5mm <sup>2</sup>
dimensions	2 modules (35 mm)
fixing	on rail TH-35

output 5-6 galvanic separated

In dry conditions, the relay's contact remains in the 7-4 position. Once the sensor becomes flooded with liquid, the red LED indicator lights up, and the contact is shifted to the 7-8 position. After the level of the conductive liquid decreases (and the electrodes of the flooding sensor depart), the contact returns to position 7-4.

## TWO-POSITION

### PZ-829 / PZ-829 RC ADJUSTABLE SENSITIVITY

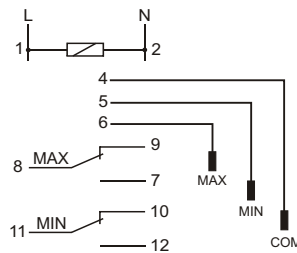

supply	230V AC
current load	2x(<16A)
contact	2x1C/O
sensitivity	PZ-828 (factory setting) 50KΩ
	PZ-828 RC (adjustable) 4,5÷220KΩ
contact switching delay	
	for level MIN 1+2sec
	for level MAX 1+2sec
power supply indicator	green LED
working mode indicator	2xred LED
power consumption	1,1 W
terminal	screw terminals 2,5mm <sup>2</sup>
dimensions	3 modules (52,5 mm)
fixing	on rail TH-35

output 4-5-6 galvanic separated

After the liquid level decreases to MIN (i.e. electrodes MIN and COM spaced), the MIN joint is switched to position 11-12, whereas the MAX joint remains in position 8-9. On the other hand, when the MAX liquid level is reached (MAX and COM electrodes shorted), the relay's MIN joint will be switched to position 11-10, whereas the MAX into position 8-7.

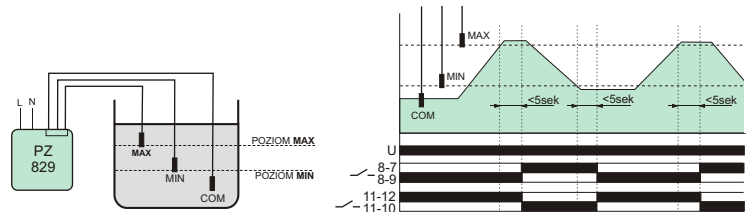

## THREE-POSITION

### PZ-831 RC

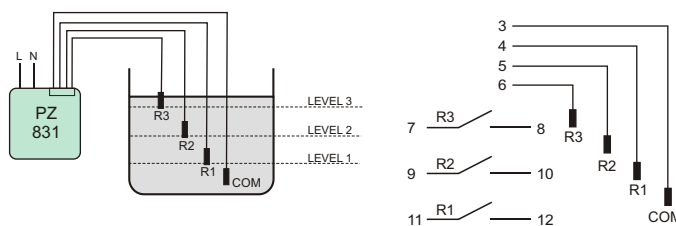

supply	230V AC
current load	3x(<8A)
contact	3x1NO
sensitivity	1÷180KΩ
contact switching delay	<2sec
power supply indicator	green LED
working mode indicator	3xred LED
power consumption	1,1 W
terminal	screw terminals 2,5mm <sup>2</sup>
dimensions	3 modules (52,5 mm)
fixing	on rail TH-35

output 3-4-5-6 galvanic separated

In dry condition (all probes open), all the transformer's contacts are also open. If the base probe COM and the next level probe are closed due to a liquid presence, the contact for a given probe will close, e.g. once the first R1 level probe (the COM base probe and the R1 level probe closed) is submerged, the 11-12 contact will close. The same procedure applies to the R2 and R3 level probes. On the other hand, once the liquid level drops below the probe level (the COM probe and the level probe open), the contact for a given probe will open as well.

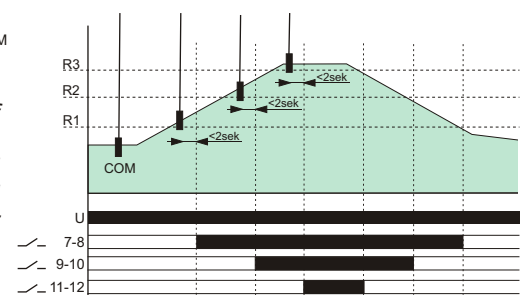

**TWO-POSITION WITH EMERGENCY STATES MIN I MAX**

**PZ-832 RC**

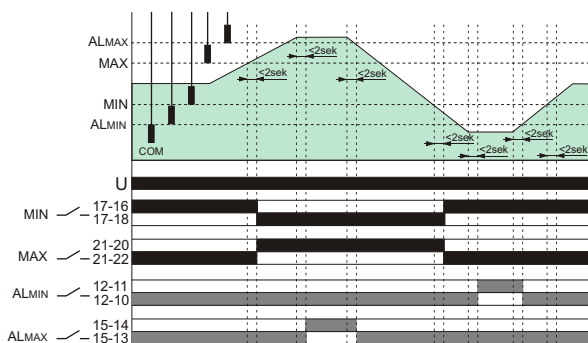
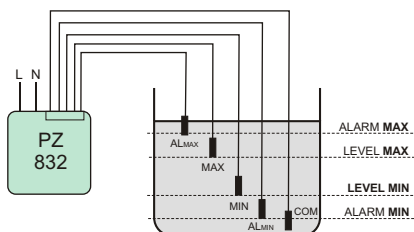

Relay control MAX and MIN statues set by user of controlled fluid. After the liquid level decreases to MIN (i.e. electrodes MIN and COM spaced), the MIN joint is switched to position 17-16 (FILLING), whereas the MAX joint remains in position 21-22. On the other hand, when the MAX liquid level is reached (MAX and COM electrodes shorted), the relay's MIN joint will be switched to position 17-18 (EMPTYING), whereas the MAX joint into position 21-20. Emergency state: **ALmin** (dry running) - after the liquid level decreases to **ALmin** (i.e. electrodes MIN and COM spaced), the ALmin joint is switched to position 12-11; **ALmax** (overflow) after level is reached **ALmax** (ALmax and COM electrodes shorted), the relay's **ALmax** joint will be switched to position 15-14.

supply	230V AC
joint	separate 4x(1P)
current load MIN and MAX	2x(<16A)
current load ALmin and ALmax	2x(<8A)
sensitivi - to set	1+100K $\Omega$
switching joints delay	1+2sec
Voltaof measured outputs	<6V
power supply	green LED
working mode	yellow LED
state MIN and MAX	2xgreen LED
state ALmin and ALmax	2xred LED
power consumption	1,1W
connection	screw terminals 2,5mm <sup>2</sup>
dimensions	3 modules (52,5mm)
fixing	on rail TH-35

joints 4-5-6 -7-8 galvanic separated

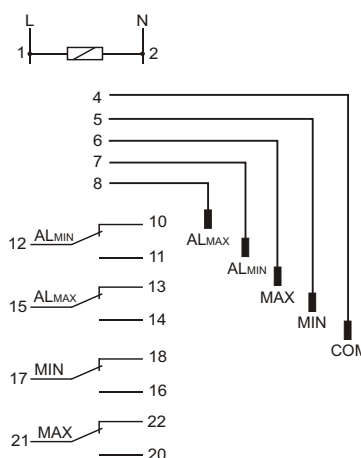

**PROBE PZ**



flooding probe	electrode
dimension of probe/lengthof cable	30x20x5mm/1,5m
length/pitch of electrodes	30mm / 5mm
probe voltage	<6V~
probe current	<0,13mA
length of connection wire	<100m
dedicated	PZ-828, PZ-828 RC

**PROBE PZ2**



flooding probe	acid-resistant steel electrode in + plastic box for electrode + gland PG9
dimension of probe	R15, l=9,5cm
probe voltage	<6V~
probe current	<0,13mA
connection cable	e.g. <1mm <sup>2</sup>
length of connection wire	<100m
dedicated	PZ-829, PZ-829 RC PZ-831 RC, PZ-832 RC

**How to connect the probe**

The design of the probe makes it possible to install the probe on a flat horizontal base, for example on the floor in a room where hydro-valves and flow pipes are installed or in a laundry room. Thanks to such a design of the probe, any failure or flooding of a room with a liquid can be quickly detected as well as electric circuits can be simultaneously switched off or the sound or light signalling system (alarm system) can be actuated. The probe cable can be extended to 100m.

A maximum of 10 probes can be connected in parallel connection or in series connection to 5-6 output:

**series connection** - for a dependant system that controls the level of liquid in many points a simultaneous short-circuit of all sensors connected must occur in order to activate the relay.

**parallel connection** - for an alternative system that controls the level of liquid in many points - a short-circuit of at least one of the sensors connected must occur.

In case of a series connection, the sensitivity of the sensors is reduced (conductivity is

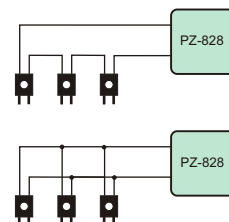

# 25. TEMPERATURE REGULATORS

**PURPOSE**

Temperature regulators may be used for equipment control in anti-freeze systems which prevent the freezing of gutters, the accumulation of ice on stairs, vehicles, etc.

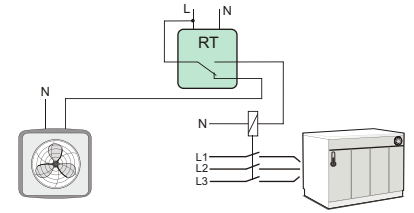

**RT-820** temperature setting range: 4÷30°C

**RT-821** temperature setting range: -4÷5°C

**RT-822** temperature setting range: 30÷60°C

**RT-823** temperature setting range: 60÷95°C

**FUNCTIONING**

The power supply to the generator is indicated by the green LED. Until the required ambient temperature is achieved, the contact of the regulator remains in position 2-1 and the heating device is active. Once the set value is achieved, the contact shifts into position 2-8 and the heating or ventilation device is turned off. Any drop in temperature by the hysteresis value will activate the heating device again (contacts 2-1 closed) until the set temperature value is achieved.

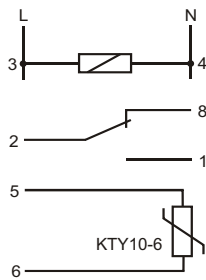

supply	230V AC
current load	<16A
contact	1 C/O
temperature setting range	
RT-820	4÷30°C
RT-821	-4÷5°C
RT-822	30÷60°C
RT-823	60÷95°C
hysteresis setting range	0,5÷3°C
temperature probe	RTR / RT2
power supply indicator	green LED
operation mode indicator	yellow LED
power consumption	1,1W
terminal	screw terminals 2,5mm <sup>2</sup>
dimensions	2 modules (35mm)
fixing	on rail TH-35

**RT-826 DIGITAL** temperature setting range: -25÷130°C

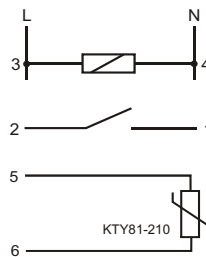

supply	230V AC
current load	<16A
contact	1 C/O
temperature setting range	-25÷130°C
hysteresis setting range	1÷30°C
adjusting precision	1°C
measure precision	±1°C
display	3×segment LED 5×9mm
temperature probe	RT / RT2
power supply indicator	green LED
operation mode indicator	yellow LED
power consumption	1,1W
terminal	screw terminals 2,5mm <sup>2</sup>
dimensions	2 modules (35mm)
fixing	on rail TH-35

- working mode: HEATING / COOLING
  - indication correction ±5°C
  - audible indication of alarm status when the temperature exceeded ± 5 ° C
- Oriented (internal piezoelectric hooter)

**PROBE RT**



temperature sensor	KTY 81-210
measurement range	-50÷130°C
working temperature	-50÷65°C
dimansion	Ø5; h=20mm
isolation of sensor	PC
cable	PC 2×0,34mm <sup>2</sup> ; l=2,5m

**PROBE RT2**



temperature sensor	KTY 81-210
measurement range	-50÷130°C
working temperature	-50÷65°C
dimansion	Ø8; h=40mm
isolation of sensor	brass muff
cable	heatresist SIHF 2×0,5mm <sup>2</sup> ; l=2,5m

FOR HOME APPLICATIONS

**RT-824** temperature range: 5÷35°C

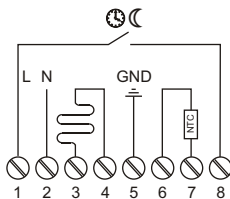

supply	230V AC
current load	<16A
contact	1 NO
temperature setting range	5÷35°C
hysteresis setting range	3°C
set value accuracy	±1°C
temperature sensor	NTC
length of probe with sensor	3m cable
power consumption	0,8W
terminal	screw terminals 1,5mm <sup>2</sup>
dimensions	
front	83,5×83,5mm; gt.22mm
back	Ø50; gt.27,5mm
fixing	to under plaster box Ø60mm

**FUNCTIONS**

- \* possibility of programming 1 required temperature
- \* the knob located on the front panel enables setting a required temperature
- \* the breaker switch located on the front panel enables switching off the power supply of the whole heating system
- \* the input for connecting a control clock
- \* signalling of the heating system activation
- \* 2 temperature sensors: an internal one and an external one
- \* 3 operation modes of the regulator: operation with the internal temperature sensor; operation with the external temperature sensor; operation with two temperature sensors
- \* in the mode of operation with the internal temperature sensor: in case of the failure of the temperature sensor the regulator will shift to the so-called safe automatic model and will try to maintain the temperature set
- \* automatic switching over to the mode of operation with the internal temperature sensor in case of a failure of the external sensor
- \* in the mode of operation with two temperature sensors, the external sensor is the limiting one and it does not permit the temperature of 27°C to be exceeded regardless of the temperature set by means of the temperature adjusting knob
- \* in the mode of operation with two temperature sensors: if both temperature sensors fail, the regulator will shift to the so-called safe automatic model. Working with interruptions, the regulator will try to maintain the temperature at the level of 80% of the set temperature.

**RT-825** temperature range: 5÷60°C

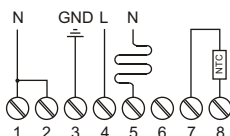
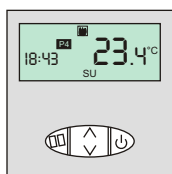

supply	230V AC
current load	<16A
contact	1 NO
temperature setting range	15÷50°C
antifrost temperature range	0÷10°C
set value accuracy	±1°C
temperature sensor	NTC
length of probe with sensor	3m cable
RTC clock	<1h
power consumption	0,8W
terminal	screw terminals 1,5mm <sup>2</sup>
dimensions	
front	83,5×83,5mm; gt.22mm
back	Ø50; gt.27,5mm
fixing	

**FUNCTIONS**

- \* the control panel enables programming and monitoring the device operation
- \* the breaker switch located on the front panel enables switching off the power supply of the whole heating system
- \* maintaining a preset temperature in accordance with programmed hours and days of the week
- \* possibility of programming 4 intervals of a required temperature per 24 hours
- \* 12 program entries: 4 entries concerning the required temperature for working days (Pn-Pt: Monday through Friday); 4 entries concerning the required temperature for Saturday (So: Saturday) and 4 entries concerning the required temperature for Sunday (Nd: Sunday)
- \* possibility of a quick, manual correction of the currently maintained temperature
- \* adjustable hysteresis
- \* 2 temperature sensors: an internal one and an external one
- \* 3 operation modes of the regulator: operation with the internal temperature sensor; operation with the external temperature sensor; operation with two temperature sensors
- \* in the mode of operation with two temperature sensors, the external sensor is the limiting one with an adjustable temperature within the range of 15÷50°C

**PROBE RT-45**



temperature sensor	NTC
working temperature	-50÷65°C
dimension	Ø7; h=25mm
isolation of sensor	PC muff
cable	PC 2×0,34mm <sup>2</sup> ; l=3m
dedicated	RT-824, RT-825

# PROGRAMMABLE

## PURPOSE

The CRT controllers are multi-function, programmable electronic devices which enable control of heating or cooling devices in order to maintain a stable room temperature, as well as to control ambient and substance temperatures in industrial conditions, with the option of supervising technological processes.

## FOR HOME APPLICATIONS

### CRT-04 temperature range: 0÷60°C

#### FUNCTIONING

The operation time and required temperature are achieved according to the individual program set by the user. The CRT controllers are equipped with a calendar and a real time clock which enable switching the controlled device on and off at preset hours within the following cycles: 24-hour, weekly, business-day (Mon. Fri.) or weekend (Sat., Sun.).

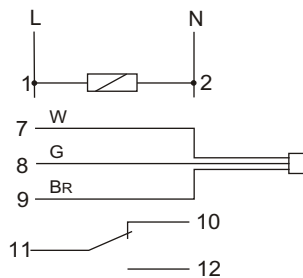
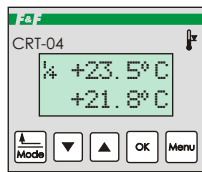

supply	230V AC
current load	<16A
contact	1 C/O
temperature setting range	0÷60°C
hysteresis setting range	0÷10°C
set value accuracy	0,1°C
model correction	±5°C
lagged switching - regulated	1÷15min
type of temperature sensor	RT4
length of probe with sensor	2,5m cable
power consumption	1,5W
terminal	screw terminals 2,5mm <sup>2</sup>
dimensions	3 modules (52,5mm)
fixing	on rail TH-35

#### CONTROLLER'S FEATURES:

- \*control panel for programming and monitoring;
- \*operation modes: HEATING and COOLING to maintain a preset temperature according to programmed hours and days;
- \*CONTINUOUS operating mode to maintain a single preset temperature value while ignoring other program entries;
- \*MEASUREMENT operating mode display of an actual temperature value without controlling a connected machine;
- \*50 program entries;
- INTERVAL this feature enables the user to program up to 8 required temperature values (3 in the MY1, MY2 and MY3 modes, and an additional 5 in modes called MORNING, WORK, DINNER, DAY, and NIGHT for everyday time windows related to the users' lifestyle);
- \*DELAY programmable time of response delay while exceeding limit temperature values;
- \*CORRECTION related to the temperature read-out error against the model thermometer;
- \*SENSORS visual signalisation of the temperature sensor failure;
- \*DST automatic DST time implementation with programmable shift to manual mode;
- \*LIGHT selection of display illumination mode.
- \*LANGUAGE program menu in three languages: Polish, English or Russian

#### Menu (example)

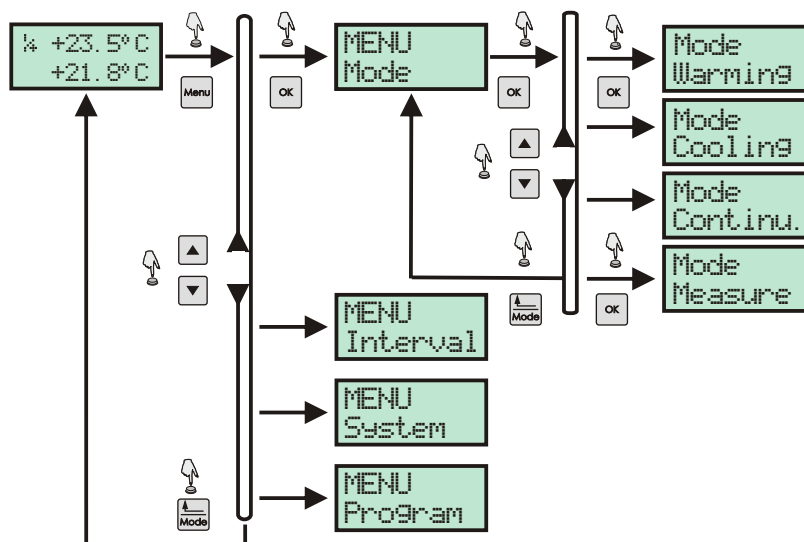



**INDUSTRIAL  
FUNCTIONING**

The controller responds to a selected function on the basis of individual entries concerning parameters like temperature, hysteresis, response delay, and other values preset by the user.

**CRT-05 2-FUNCTION temperature range: -100÷400°C**

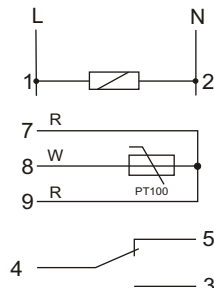
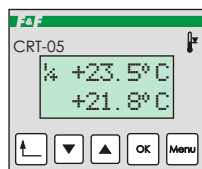

supply	230V AC
current load	<16A
contact	1 C/O
temperature setting range	-100÷400°C
hysteresis setting range	0÷100°C
set value accuracy	1°C
model correction	±20°C
lagged switching - regulated	0÷45min
gradient - regulated	4°C/1sec
type of temperature sensor	PT100
power consumption	1,5W
terminal	screw terminals 2,5mm <sup>2</sup>
dimensions	3 modules (52,5mm)
fixing	on rail TH-35

**CONTROLLER'S FEATURES:**

- \*control panel for programming and monitoring;
- \*2 operations modes: HEATING and COOLING
- \*2 regulated HYSTERESIS values lower and upper limits;
- \*AUTOMATIC mode operation with one selected function;
- \*MANUAL mode permanent closing or opening of the contact without a temperature measurement.
- \*CORRECTION related to the temperature read-out error against the model thermometer;
- \*WARNING - visual signalisation of the temperature sensor failure, range exceed and speed rising or falling temperature exceed
- \*limiting access to program menu using PIN code
- \*LIGHT selection of display illumination mode.
- \*LANGUAGE program menu in three languages: Polish, English or Russian

**HEATING**

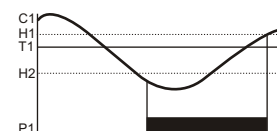

**COOLING**

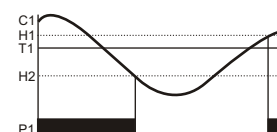

**CRT-06 10-FUNCTION temperature range: -100÷400°C**

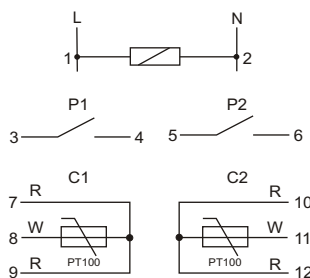
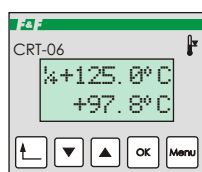

supply	230V AC
current load	2x(<16A)
contact	1 C/O
temperature setting range	-100÷400°C
hysteresis setting range	0÷100°C
set value accuracy	1°C
model correction	±20°C
lagged switching - adjustable	0÷45min
gradient - regulated	4°C/1sek÷6°C/1min
sampling frequency - regulated	1÷120probek/1min
type of temperature sensor	PT100
power consumption	1,5W
terminal	screw terminals 2,5mm <sup>2</sup>
dimensions	3 modules (52,5mm)
fixing	on rail TH-35

**CONTROLLER'S FEATURES:**

- \*control panel for programming and monitoring;
- \*10 operation functions;
- \*2 independent temperature sensors;
- \*two independent temperature values may be set;
- \*2 x 1P contacts applied to the temperature sensors;
- \*2 hysteresis set values, one for each sensor;
- \*AUTOMATIC mode - operation with one selected function;
- \*MANUAL mode permanent closing or opening of the contact without a temperature measurement. Separate temperature drops for the P1 and P2 contacts.
- \*memory feature for maximum and minimum temperature values registered, independent for the C1 and C2 sensors;
- \*CORRECTION related to the temperature read-out error against the model thermometer;
- \*WARNING - visual signalisation of the temperature sensor failure, range exceed and speed rising or falling temperature exceed
- \*limiting access to program menu using PIN code
- \*LIGHT selection of display illumination mode.
- \*LANGUAGE program menu in three languages: Polish, English or Russian

**OPERATIONAL FUNCTIONS OF THE CRT-06**

**PROG 1**

HEATING mode. The P1 and P2 contacts depend on the C1 sensor.

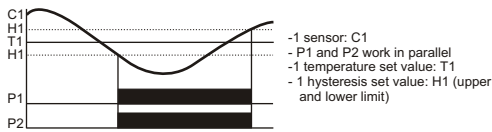

**PROG 2**

COOLING mode. The P1 and P2 contacts depend on the C1 sensor.

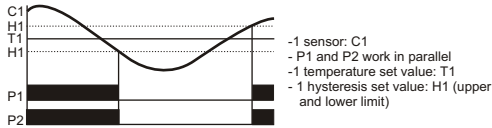

**PROG 3**

HEATING / COOLING modes. The P1 and P2 contacts depend on the C1 sensor.

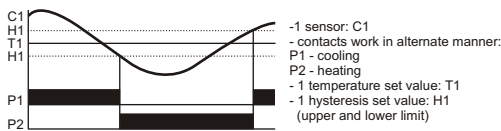

**PROG 4**

For contacts P1 and P2. The P1 contact dependent on the C1 sensor, the P2 on the C2 sensor.

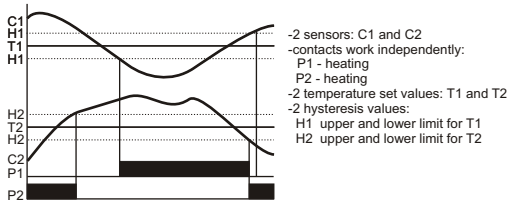

**PROG 5**

COOLING mode for the P1 and P2 contacts. The P1 contact depends on the C1 sensor, the P2 on the C2 sensor.

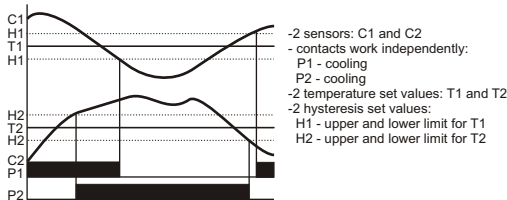

**PROG 6**

HEATING mode for the contacts P1 and P2. The P1 contact depends on the C1 sensor, and the P2 on the C2 and C1 (activated only with the P1 contact closed).

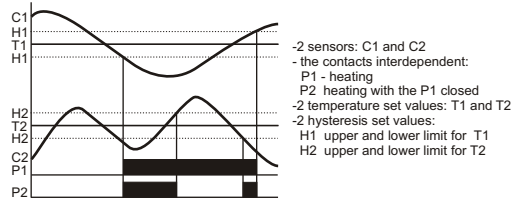

**PROG 7**

DIFFERENTIAL mode. The P1 contact closed with the temperature difference exceeding the set value. The P2 contact activated in the reversed conditions in comparison to the P1, i.e. with the temperature difference lower than the set value.

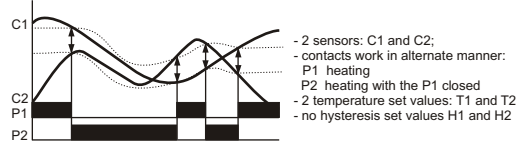

**PROG 8**

WINDOW mode. The P1 and P2 contacts closed when the C1 sensor temperature is between the preset temperature values of T1 and T2.

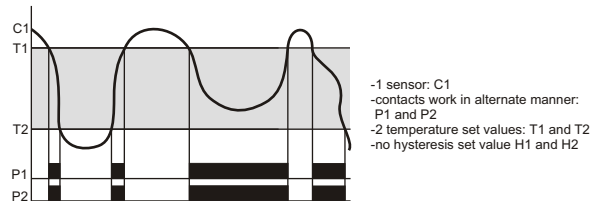

**PROG 9**

WINDOW mode. The P1 and P2 contacts closed when the C1 and C2 sensors temperature is between the preset temperature values of T1 and T2.

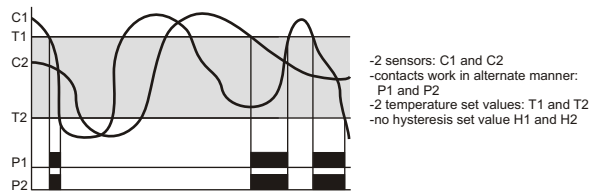

**PROG 10**

WINDOW mode independent for the P1 and P2 contacts. The P1 contact closed when the C1 sensor temperature is between the preset temperature values of T1 and T2. The P2 contact closed when the C2 sensor temperature is between the preset temperature values of T3 and T4.

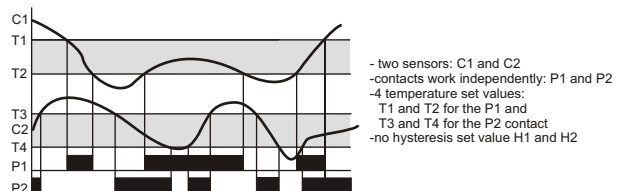

**PROBE RT4**



temperature sensor	DS18S20
measurement range	-55+125°C
working temperature	-30+65°C
dimension	Ø5; h=30mm
isolation of sensor	PC
cable	LiYY 3x0,34mm² l=2,5m
dedicated	CRT-04

**PROBE RT-56**



temperature sensor	PT100
measurement range	-100+400°C
dimension	Ø4; h=85mm
isolation of sensor	steel muff
cable	PC 3x0,34mm²; l=1,5m in metal braid sheath
dedicated	CRT-05, CRT-06

## CRT-15T *temperature range: 0÷400°C*

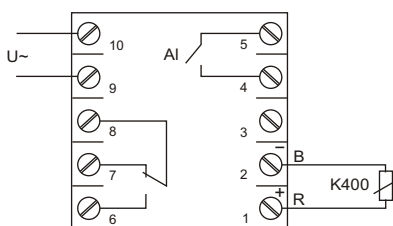

supply	100÷240V
current load	<3A
contact	1 C/O
load current for alarm output	<1A
alarm output contact	1 NO
temperature setting range	0÷400°C
PID set value	
proportional section P	0÷100
integrating section I	0÷255
differentiating section D	0÷255
set value accuracy	0,5°C
model correction	±15°C
lagged switching - regulated	0÷45min
gradient - regulated	4°C/1sec
type of temperature sensor	K400
power consumption	1W
terminal	screw terminals 2,5mm <sup>2</sup>
dimensions	48×48×86

### CONTROLLER'S FEATURES:

- \*control panel for programming and monitoring of device operation;
- \*PID controller (a proportional-integral-derivative controller);
- \*automatic tuning of the PID regulator;
- \*ALARM programmable temperature limit to trigger off the alarm feature;
- \*preset temperature indications;
- \*current temperature indications;
- \*1P output contact;
- \*additional ALARM output: 1Z contact
- \*CORRECTION related to the temperature read-out error against the model thermometer;
- \*LOCK settings block.

### PROBE K400



temperature sensor	K400
dimansion	thread M6; h=15mm
isolation of sensor	steel
cable	2×0,34mm <sup>2</sup> l=1,0m in steel weave

## RESISTANCE (THERMAL) RELAY

### CR-810 TO CO-OPERATION WITH THE PTC THERMISTOR-EQUIPPED TEMPERATURE SENSORS.

#### PURPOSE

The resistance relay protects electrical equipment against any undesirable temperature increases by means of PTC resistors in serial connection (1-6 pieces).

#### FUNCTIONING

Correct operation (closed contacts 3-7) is indicated by the green LED (correct power voltage, temperature of the controlled device, working circuit of connected PTC sensors). The increase in temperature of at least one sensor over the rated value results in an increase in its resistance over 3000Ω. The relay is then activated (contacts 3-7 open). The system is activated automatically if the resistance of the PTC sensor loop decreases below the threshold of 1800Ω (drop in temperature of the controlled device). The contact of the executive relay also opens in the event of the resistance dropping to 15Ω (e.g. during a short circuit between cables) or with the power voltage turned off.

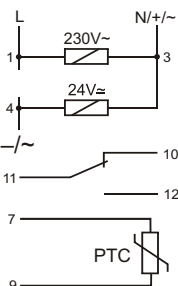
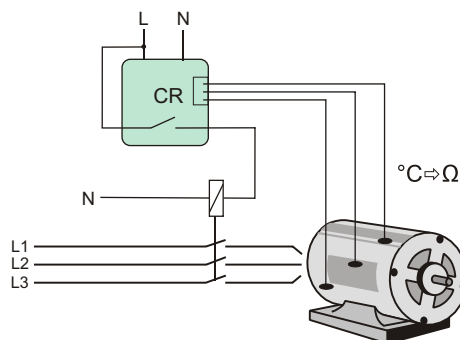

supply	230V AC / 24V AC/DC
current load	<16A
contact opening resistance	R>3000Ω, R<70Ω
contact closure resistance	110Ω<R<1800Ω
max resistance of sensor loop when cold	R=1500Ω
power supply / correct conditions indicator	green LED
damage conditions indicator	2×red LED
working temperature	-25÷50°C
terminals	screw terminals 2,5 mm <sup>2</sup>
dimensions	1 module (18 mm)
fixing	on rail TH-35

# 26. CONTROL SYSTEM COMPONENTS

## ELECTROMAGNETIC RELAYS

### PURPOSE

Electromagnetic relay in single-module casing intended for direct assembly on the TH-35 bus bar.

### FUNCTIONING

Application of the power supply voltage to the relay's coil results in a shift of the contact. After the decay of the voltage in question, the contact returns to the initial position.

**PK-1P** Contact 1C/O (16A).

**PK-2P** Contacts 2C/O (2×8A).

**PK-3P** Contacts 3C/O (3×8A).

**PK-4PZ** Contacts 2C/O (2×8A) + 2NO (2×8A).

**PK-4PR** Contacts 2C/O (2×8A) + 2NC (2×8A).



Order labelling method:

PK-2P 48V — supply voltage

appl. standard no.	IEC 61095
power supply	
PK-xP 230V	230V AC
PK-xP 110V	110V AC/DC
PK-xP 48V	48V AC/DC
PK-xP 24V	24V AC/DC
PK-xP 12V	12V AC/DC
connection current	
PK-1P	Ie=16A
PK-2P	Ie=2×8A
PK-3P	Ie=3×8A
PK-4PZ	Ie=4×8A
PK-4PR	Ie=4×8A
connection voltage	Ue=250V
usage category	AC-7a
insulation voltage	400V
voltage surge resistor	contact pair coil, 6 kV
separate current circuits	3.6 kV
contact gap	1.2 kV
pollution level	3
overvoltage capacity	6 kV
safety label	B
protection level	IP20
operating time	max. 40 msec
turn-off time	max. 20 msec
mechanical life	5 × 10 <sup>6</sup> cycles
current consumption	25mA
voltage indicator	LED
terminal	screw terminals 2.5 mm <sup>2</sup>
working temperature	-25+50°C
dimensions	1 module (18 mm)
fixing	on rail TH-35

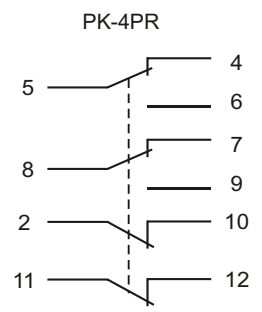
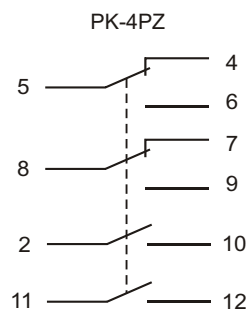
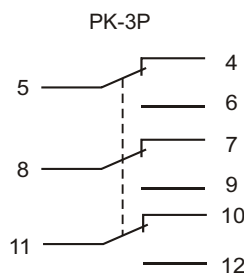
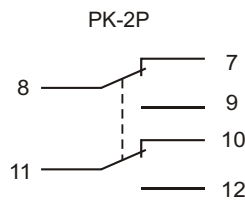
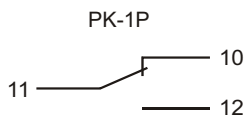

### Loadability for contats of relays

	BULBS HALOGEN LIGHTS	INCOMPENSATED FLUORESCENT LIGHTS	COMPENSATED OF FLUORESCENT LIGHTS	FLUORESCENT LIGHTS COMPENSATED IN PARALLEL	ECONOMIC FLUORESCENT LIGHT	ALTERNATING CURRENT			DIRECT CURRENT
						AC-1	AC-3	AC-15	DC-1 24V/230V
						non-inductive or low-inductive loads resistive furnance	squirrel-cage motor switching motors in operation	controlling of alternative electro-magnetic loads	non-inductive or low-inductive, resistive furnances
5A	600W	300W	300W	200W	240W	1800VA	0,30KW	280VA	5A/012A
8A	1100W	550W	550W	350W	300W	2200VA	0,45KW	325VA	8A/0,18A
10A	1500W	650W	650W	500W	350W	2500VA	0,6KW	500VA	10A/0,25A
16A	2300W	1000W	1000W	800W	550W	4200VA	1KW	750VA	16A/0,35A
30A	4000W	1900W	1900W	1500W	1000W	7500VA	1,7KW	1400VA	30A/0,7A

## MODULAR CONTACTORS

### PURPOSE

Electromagnetic contactors in modular case for direct mounting on rail 35mm.

### FUNCTIONING

Connect the voltage on the contactor's coil will switch the contact. Contactor's status is indicated by blinking red marker in the box. After a loss of power the contacts return to their original position.



ST-25



ST-40



ST-63

Type	Contacts	Power Cat. AC1	Coil supply voltage	Power consumption	Module	Weight	Screw terminals
ST25-20	2NO	25A	230V AC	2,2W	1	106g	4mm <sup>2</sup>
ST25-20/24	2NO	25A	24V AC	2,2W	1	106g	4mm <sup>2</sup>
ST25-11	1NO+1NC	25A	230V AC	2,2W	1	106g	4mm <sup>2</sup>
ST25-30	3NO	25A	230V AC	4,0W	2	168g	4mm <sup>2</sup>
ST25-31	3NO+1NC	25A	230V AC	4,0W	2	168g	4mm <sup>2</sup>
ST25-31/24	3NO+1NC	25A	24V AC	4,0W	2	168g	4mm <sup>2</sup>
ST25-40	4NO	25A	230V AC	4,0W	2	168g	4mm <sup>2</sup>
ST25-22	2NO+2NC	25A	230V AC	4,0W	2	168g	4mm <sup>2</sup>
ST25-04	4NC	25A	230V AC	4,0W	2	168g	4mm <sup>2</sup>
ST25-40/24	4NO	25A	24V AC	4,0W	2	168g	4mm <sup>2</sup>
ST40-40	4NO	40A	230V AC	6,4W	3	241g	10mm <sup>2</sup>
ST40-40/24	4NO	40A	24V AC	6,4W	3	241g	10mm <sup>2</sup>
ST40-31	3NO+1NC	40A	230V AC	6,4W	3	241g	10mm <sup>2</sup>
ST63-40	4NO	63A	230V AC	6,4W	3	241g	10mm <sup>2</sup>
ST63-40/24	4NO	63A	24V AC	6,4W	3	241g	10mm <sup>2</sup>
ST63-31	3NO+1NC	63A	230V AC	6,4W	3	241g	10mm <sup>2</sup>

Standard number	IEC 61095
Number of a cycles	3×10 <sup>5</sup>
Protection level	IP20
Working temperature	-25+50°C

### Contacts description

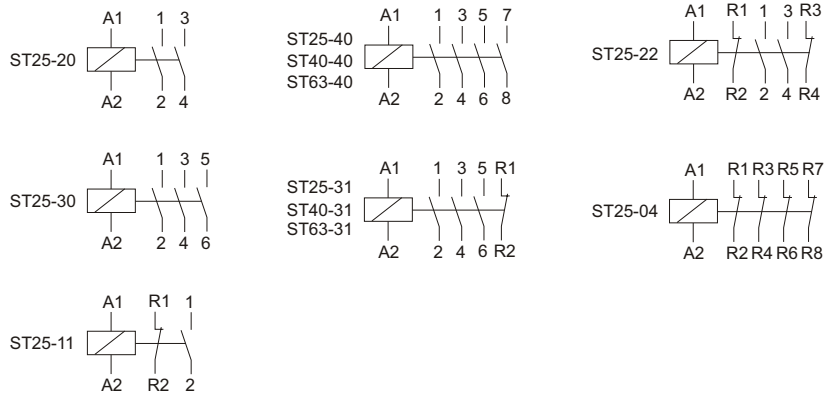

### Dimensions

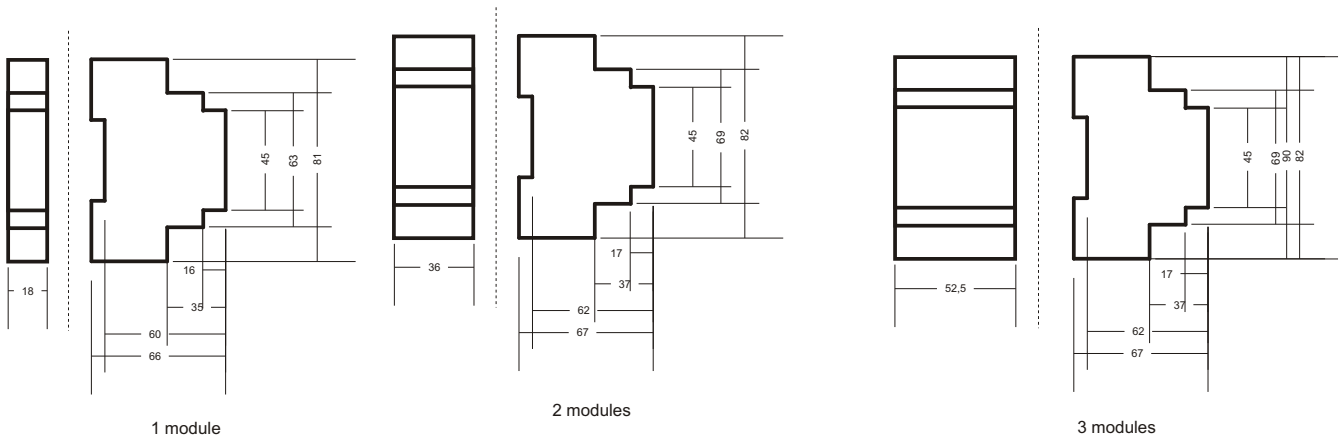

## SEP-01 SEPARATOR OF INPUT SIGNAL

### FUNCTIONING

The SEP-01 serve to separating of input signal in automatic arrangement with separated control groups and central control. Input signal goes in "one way".

Example of use: Central control - look chapter 4

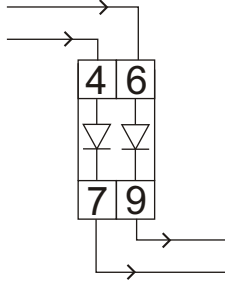

current load	<1A 1000V
working temperature	-25+50°C
terminal	screw terminals 2,5mm <sup>2</sup>
dimensions	1 module (18mm)
fixing	on rail TH-35

## PSI-02 CONTINUOUS - PULSE SIGNAL CONVERTER

### FUNCTIONING

The PSI-02 converter serves to break up a control signal into single pulses required in automatic control systems.

After the application of the control signal to the U<sub>ST</sub> input (leading edge), the converter generates a pulse on output 6 (contact 5-6 closed for 1 second). After the decay of the control signal (trailing edge), the converter sends another pulse on output 8 (contact 7-8 closed for 1 second).

Example of use: Roller blinds group control system (see chapter 22).

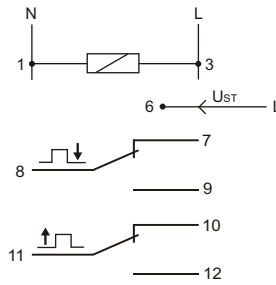
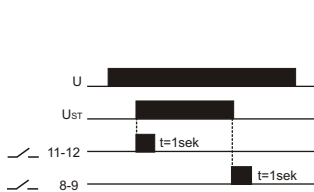

supply	PSI-02 230V	230V AC
	PSI-02 24V	24V AC/DC
current load	<2x8A	
contact	separated	2x1N/O
input signal		230V AC
time of input signals		1sec
working temperature		-25+50°C
terminal		screw terminals 2,5mm <sup>2</sup>
dimensions		1 module (18mm)
fixing		on rail TH-35

## MPG-03 FULL-WAVE BRIDGE RECTIFIER (in GREATZ circuit)

### PURPOSE

The MPG-02 changes alternating current into unidirectional direct current.

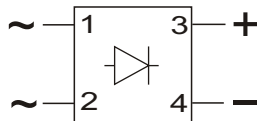

supply	110+264V AC
	12+48V AC
current load	<2A
signalization of supply	LED green
working temperature	-25+50°C
terminal	screw terminal 2,5mm <sup>2</sup>
dimensions	1 module (17,5mm)
fixing	on rail TH-35

## LT-04 TERMINATION / POLARISATION MODULE NETWORK RS-485

### PURPOSE

LT module is used to termination of signal line (UTP cable) between devices exchange data according to the standard MODBUS protocol on the network RS-485.

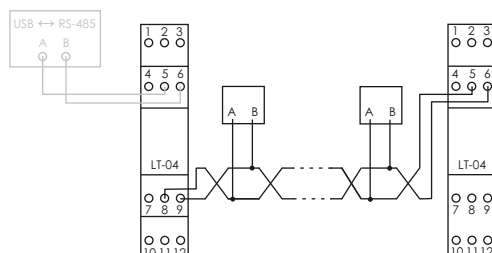

supply	15+30V DC
current	<10mA
working temperature	-25+50°C
connection	screw terminals 2,5mm <sup>2</sup>
dimensions	1 module (18mm)
fixing	on rail TH-35

## MGS-05 ELECTRICAL ISOLATION MODULE OF DIGITAL INPUTS

### FUNCTIONING

The module MGS is used to preserve the digital inputs PLC by introducing the galvanic protection against overvoltage of controller input of value min. 2500V. In addition, the module inputs are equipped with a RC filter to ensure effective elimination of impulse interference of less than 2ms. By separating the input power from the power output of module it is possible to separate the PLC power supply from the rest of the automatics, thereby eliminating the possibility of moving interference from the power supply of automation to PLC. It is also possible the power supply controller with a different value than the power to the rest of the automatics.

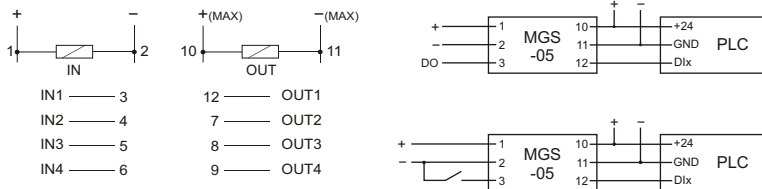

supply of side IN	9+30V DC
supply of side OUT	9+30V DC
galvanic isolation	min. 2500V <sub>rms</sub>
power consumption	<1W
connections	screw terminals 2,5mm <sup>2</sup>
dimensions	1 module (18mm)
fixing	on the rail TH-35

## ECH-06 RESERVE POWER MODULE (with battery charger 1.3 ÷ 7.2 Ah)

### FUNCTIONING

Power module and charging battery of ECH allows you to implement flexible power scheme to ensure continuity of the device after the main power failure. With the external acid battery (gel) of a nominal voltage 12V is battery reserve system. The module performs the continuous surveillance of the battery and recharges it automatically when the presence of the main supply voltage. In the case of main power failure or a decline in its value below the battery voltage of the receiver is powered from the battery.

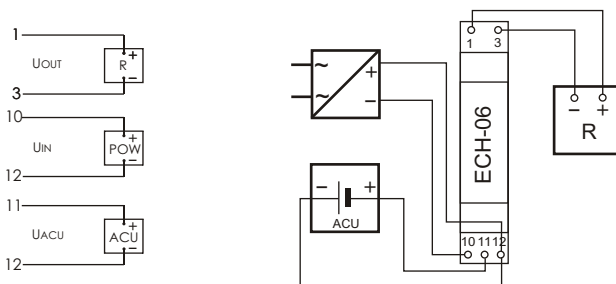

supply/charging Uin	15+30V DC
out voltage Uout	9+30V DC
	(Uin-0,5V DC / Uacu-0,5V DC)
current load out Uout	<3A
supported battery capacity	1,3+7,2Ah
max battery voltage	13,8V DC
charging current	<3A
power consumption	<1W
connection	screw terminals
dimensions	1 module (18mm)
fixing	on the rail TH-35

## OP-230 OVERVOLTAGE PROTECTOR

type 3 (early D-class) with a triple interference filter

### PURPOSE

Protection of electronic devices, i.e. computers, PLCs, microprocessor systems, etc. against electromagnetic disturbance and overvoltage in the electrical system.

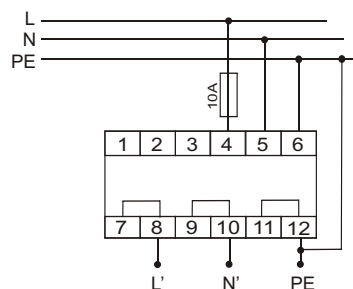

standard no	IEC 61643-1:2001
protection class	D
rated voltage	230V
rated current	10A
rated frequency	50Hz
maximum stable working voltage	255V
overvoltage protection level L•Novoltage	<1,25kV
protection level L(N)•PE	<1,5kV
operating time	<25ns
additional protection	10A gL/g Lub C10A
inductans	1mH na tor
leakage current	0,5mA
capacitance L•N	880nF
capacitance L(N)•PE	2,2nF
electromagnetic interference damping capacity	>85dB
terminal	screw terminals 2,5mm <sup>2</sup>
working temperature	-25+50°C
dimensions	3 modules (52,5mm)
weight	170g
fixing	on rail TH-35

# 27. SIGNAL TRANSMITTERS

## ANALOG TRANSMITTERS [4-20mA]

The analog transducers dedicated for measuring physical values with an external or internal sensor and converting the measured features to the standard analog current signal output 4-20mA or voltage 0 to 10V.

### TEMPERATURE TRANSMITTERS

#### AT-1I / AT-1U to cooperate with temperature sensor KTY

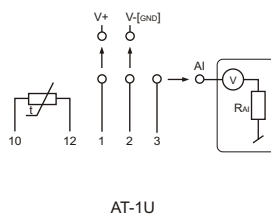
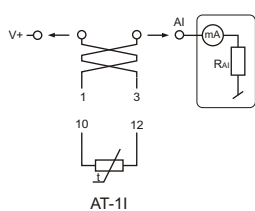

supply	9+30V DC
measure range	-50°C++100°C
mistake precision	±1,5°C
output signal	4+20mA / 0+10V
length of signal wire I / U	300m / 20m
temperature probe	RT / RT2
power consumption	0,8W
working temperature	-40°C++85°C
relative humidity	85% to +30°C
connection	screw terminals 2,5mm <sup>2</sup>
dimensions	1 module (18mm)
fixing	on the rail TH-35
protection level	IP20

The module works with resistance-type temperature sensor KTY81-210 (or similar).  
A dedicated temperature probe of F&F production : RT probe or RT2 probe (Chapter 25).

#### AT-2I / AT-2U with internal temperature sensor KTY

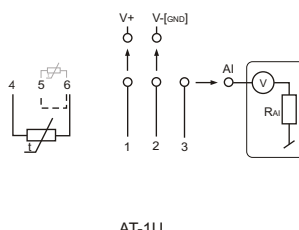
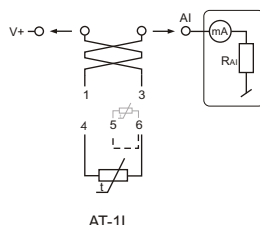

supply	9+30V DC
measure range	-50°C++100°C
mistake precision	±1,5°C
output signal	4+20mA / 0+10V
length of signal wire I / U	300m / 20m
temperature probe	RT / RT2
power consumption	0,8W
working temperature	-40°C++85°C
relative humidity	85% to +30°C
connection	screw terminals 2,5mm <sup>2</sup>
dimensions	Ø55, h=13mm
fixing	to under plaster box Ø60mm
protection level	IP20

The module works in one of two options - with the internal sensor or external probe.  
The module works with resistance-type temperature sensor KTY81-210 (or similar).  
A dedicated temperature probe of F&F production : RT probe or RT2 probe (Chapter 25).

#### AT-3I to cooperate with temperature sensor PT-100

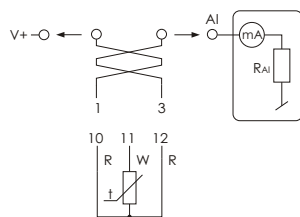

supply	9+30V DC
measure range	-100°C++400°C
mistake precision	±1°C
max. current load	4+20mA
temperature sensor	PT-100
processing error	±0,5%
length of signaling cable	<300m
working temperature	-40°C++85°C
power consumption	0,8W
relative humidity	85% to +30°C
connection	screw terminals 2,5mm <sup>2</sup>
dimensions	1 module (18mm)
assembly	on the rail TH-35
protection level	IP20

The module works with resistance-type temperature sensor PT100 (or similar).  
A dedicated temperature probe of F&F production : RT -56 (chapter 25).



## TRANSMITTERS OF MEASUREMENT VOLTAGE

### AV-11 one-phase 230V AC / 400V DC

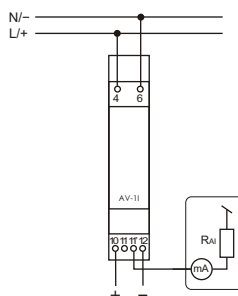
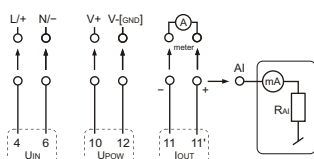

supply	9+30V DC
measure range TrueRMS	
AC	0+282,8V
DC	0+400V
max. instantaneous voltage	320V AC / 450V DC
max. measurement mistake	±0,5V
max. current load	4+20mA
length of signal cable	300m
breakdown voltage IN->OU	3KV
power consumption	0,8W
working temperature	-20°C+50°C
relative humidity	85% to +30°C
connection	screw terminals 2,5mm <sup>2</sup>
dimensions	1 module (18mm)
protection level	IP20

The transmitter measures the rms value voltage TrueRMS, which ensures high measurement accuracy even with distorted waveforms.

## CURRENT TRANSMITTER

### AC-11 5A one-phase 5A AC

### AC-11 15A one-phase 15A AC / 20A DC

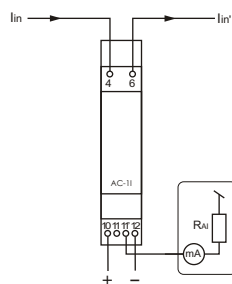
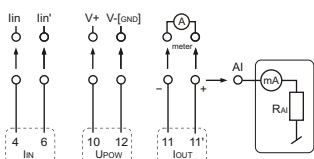

supply	9+30V DC
range of measurer TrueRMS / max.voltage	
AC-11 5A	0+5A/285V
AC-11 15A	0+15A/285VAC
	0+20A/400VDC
max. current load Iin	<10AAC
permissible overload	100A/100msek
output signal	4+20mA
length of signal cable	300m
breakdown voltage IN->OUT	2,1KV
max measure mistake	±0,2A
processing mistake	±0,5%
power consumption	0,8W
working temperature	-20°C+50°C
relative humidity	85% to +30°C
connection	screw terminals 2,5mm <sup>2</sup>
dimensions	1 module (18mm)
fixing	on the rail TH-35
protection level	IP20

The transmitter measures the rms current TrueRMS, which ensures high measurement accuracy even with distorted waveforms.

## HUMIDITY TRANSMITTER

### AH-11 hermetic IP65

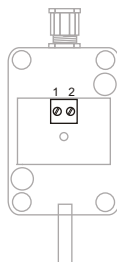
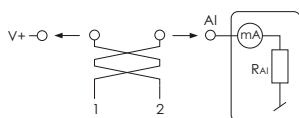

supply	9+30V DC
range of measurer	0+100%RH
accuracy (dla 25°C)	±3,5RH
inertia	5sec
output signal	4+20mA
length of signal cable	300m
breakdown voltage IN->OUT	2,1KV
max measure mistake	±0,2A
processing mistake	±0,5%
power consumption	0,8W
working temperature	-20°C+50°C
relative humidity	85% to +30°C
connection	screw terminals 1,5mm <sup>2</sup>
dimensions	42×98×30mm
fixing	on the rail TH-35
protection level	IP65

# TRANSMITTERS WITH MODBUS RTU OUTPUT

Transducers for measuring physical values with an external or internal sensor with the possibility of reading data from the internal registers using Modbus RTU protocol.

## TRANSMITTERS OF MEASUREMENT VOLTAGE

### MB-1U-1 one-phase / MB-3U-1 three-phase

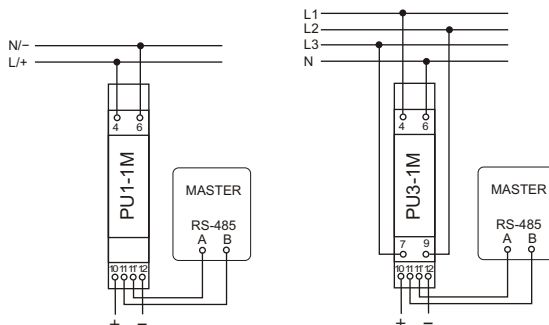

supply	9+30V DC
max. current load	50mA
measure TrueRMS range	
AC	0+285V
DC	0+400V
measure mistake	0,5%
reading registry precision	1V
breakdown voltage IN->OUT	3kV
mistake precision	±0,5%
sampled frequency	10Hz
port	RS-485
communication protocol	Modbus RTU
work mode	SLAVE
communication parameters	speed;9600bit/sec data bits; 8, stop bits;2, parity bits:no
address	10+19
working temperature	-20°C+50°C
relative humidity	85% for +30°C
connection	screw terminals 2,5mm <sup>2</sup>
dimensions	1 module (18mm)
protection level	IP20

The transmitter measures the rms value voltage TrueRMS, which ensures high measurement accuracy even with distorted waveforms.

## CURRENT TRANSMITTER

### MB-1I-1 5A / MB-1I-1 15A one-phase

### MB-3I-1 5A / MB-3I-1 15A three-phase

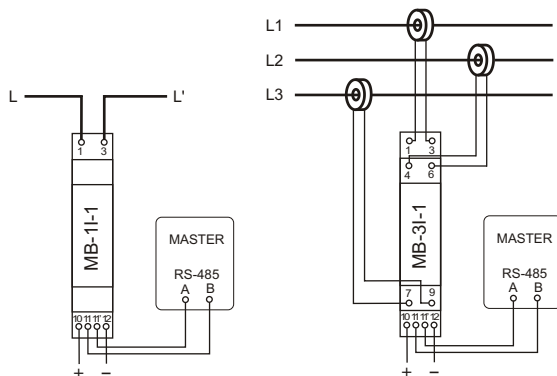

supply	9+30V DC
max. current load	50mA
measure TrueRMS range / max. voltage	
AC-1I 5A	0+5A/285V
AC-1I 15A	0+15A/285VAC
	0+20A/400VDC
measure mistake	±0,5%
reading registry precision	0,1A
breakdown voltage IN->OUT	2,1kV
sampled frequency	10Hz
port	RS-485
communication protocol	Modbus RTU
work mode	SLAVE
communication parameters	speed;9600bit/sec data bits; 8, stop bits;2, parity bits:no
address	20+29
working temperature	-20°C+50°C
relative humidity	85% for +30°C
connection	screw terminals 2,5mm <sup>2</sup>
dimensions	1 module (18mm)
protection level	IP20

The transmitter measures the rms current TrueRMS, which ensures high measurement accuracy even with distorted waveforms.

## TEMPERATURE TRANSMITTERS

### MB-PT-1 to cooperate with temperature sensor PT-100

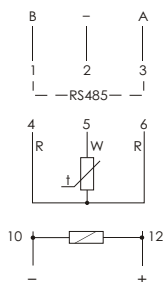

supply	9+30V DC
measure range	-100°C+400°C
mistake precision	±1°C
reading registry precision	1°C
temperature sensor	PT-100
processing error	±0,5%
sampled frequency	10Hz
port	RS-485
communication protocol	Modbus RTU
work mode	SLAVE
communication parameters	speed;9600bit/sec data bits; 8, stop bits;2, parity bits:no
address	20+29
working temperature	-20°C+50°C
relative humidity	85% for +30°C
connection	screw terminals 2,5mm <sup>2</sup>
dimensions	1 module (18mm)
protection level	IP20

The module works with resistance-type temperature sensor PT100 (or similar). A dedicated temperature probe of F&F production : RT -56 (chapter 25).

# EXTENSION MODULES

MR module is dedicated as an external I/O expansion device for PLC controllers or other devices where data exchange is via the RS485 port in accordance with MODBUS RTU.

## MR-DIO-1 DIGITAL I/O EXTENSION MODULE (DI/DO)

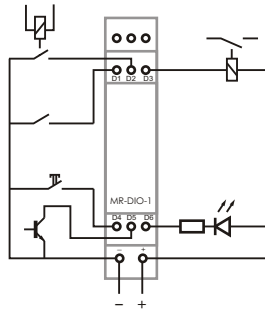
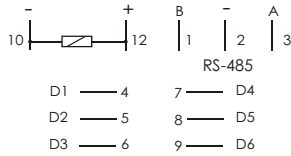

power supply	9+30V DC
max current load	25mA
contact number DI/DO	6
voltage contact	<50V
work current contact: constant / pulse(20%)	100mA/200mA
port	RS485
communication protocol	MODBUS RTU
work mode	SLAVE
communication param.	No of bits per second: 9600 Data bits: 8, Parity: no, Start bits: 1, Stop bits: 2
base address range	70+79
working temperature	40°C++50°C
storage temperature	-40°C++70°C
Relative humidity	85% dla +30°C
fixing	screw terminals 1,5mm <sup>2</sup>
dimensions	1 modul (18 mm)
IP protection	IP20

Module MR-DIO-1 has six universal contacts. Each of the contacts depending on how the connection can be a digital input or output. The module has a recording of output function in non-volatile local memory. After each power-output module will revert to a saved state.

## MR-AI-1 ANALOG INPUT EXTENSION MODULE (AI)

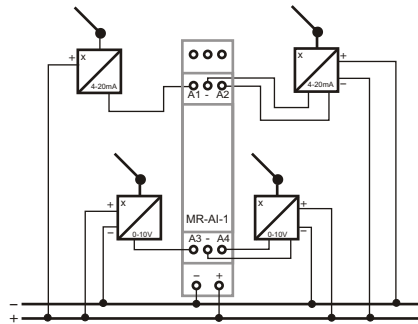
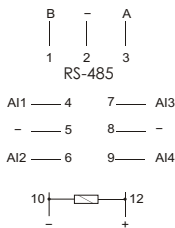

supply	9+30V DC
max. current consumption	30mA
number inputs	4
type of inputs/range	current 0+20mA voltage 0+10V
input resistance	current 110kΩ voltage 47kΩ
mistake precision	0,5%
port	RS485
communication protocol	MODBUS RTU
work mode	SLAVE
communication param.	No of bits per second: 9600 Data bits: 8, Parity: no, Start bits: 1, Stop bits: 2
base address range	90+99
working temperature	-40°C++50°C
storage temperature	-40°C++70°C
relative humidity	85% to +30°C
connection	screw terminals 2,5mm <sup>2</sup>
dimensions	1 module (18mm)
protection level	IP20

The module has 4 universal analog inputs. Input type compatible 0-10V (voltage U) or 4-20mA (current I) is determined using internal jumpers. The module measures the value of input current and voltage on all inputs regardless of the hardware configurations of input types (location of jumpers). However, they will be properly measured input values for which this entry is configured.

## MR-AO-1 ANALOG OUTPUT EXTENSION MODULE (AO)

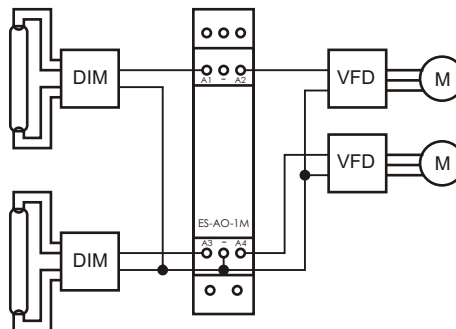
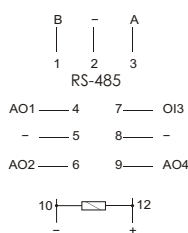

supply	9+30V DC
max. current consumption	40mA
output signal	0+10V
output signal precision	0,1V
mistake precision	±0,2%
min.output resistance	2kΩ
short-circuit current	40mA
port	RS485
communication protocol	MODBUS RTU
work mode	SLAVE
communication param.	No of bits per second: 9600 Data bits: 8, Parity: no, Start bits: 1, Stop bits: 2
base address range	100+109
working temperature	-40°C++50°C
storage temperature	-40°C++70°C
relative humidity	85% for +30°C
connection	screw terminals 1,5mm <sup>2</sup>
dimensions	1 module (18mm)
protection level	IP20

The module has 4 analog voltage outputs 0-10V. The values of the outputs volages can be set or read via RS485, using MODBUS RTU protocol. The module has the function of recording the output voltage non-volatile memory in the local area. Each time you power up the module output value will be restored to the saved state.

# 28. CURRENT TRANSFORMER

**PURPOSE**

Current transformer is used for the proportional changes of large currents to lower values, adapted to ranges of control and measuring devices.

**TI-...**

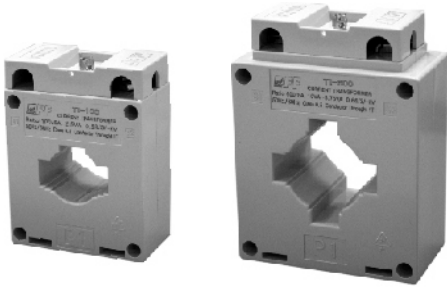

assembling accessories

no. of norm	IEC 60044-1
nominal second current Is	5A
rated voltage	0,66kV AC
insulation breakdown voltage	3kV/1min
frequency	50/60Hz
IP protection	IP20
working temperature	-5÷40°C
fixing S1/S2	screw terminals
4mm <sup>2</sup> assembly	board / busbar
position	vertical / horizontal

**FUNCTIONING**

The cable with the measured current passes through the main hole of transformer (P1/P2), which is equivalent to one coil of primary winding. Terminals of secondary winding S1 and S2 are connected to the terminals of the circuit of the measuring control device or measuring.

Ratio of intensities of currents in both windings is constant and is called the current gear:  $IPn/ISn = N$ , where  $IPn$  - rated primary current;  $ISn$  - rated secondary current,  $N$  - the value of the transmission. With the current flowing through the secondary winding can be determined the value of current flowing through the primary winding:  $ISm * N = IPm$ , where the  $ISm$  - measured primary current;  $IPm$  - measured secondary current.

**ATTENTION!**

Recommended connection of the secondary system by wire with a diameter of not less than 2,5 mm<sup>2</sup>.

Recommended grounding terminal S2.

Prohibition of disconnection of the secondary system during operation of the transformer (the possibility of high voltage resulting electric shock to person or damage of equipment).

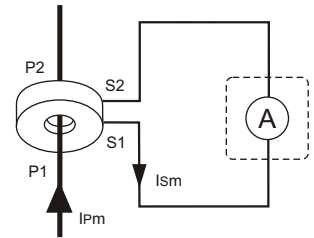

Type	transmission Ip/Is	class	power [VA]	hole dimensions P1/P2 A1/A2/A3×B; C [mm]	dimensions W×H×D [mm]	weight [kg]
TI-100	100/5	0,5	2,5	30/25/20×10; Ø10	61×81×34	0,235
TI-150	150/5	0,5	2,5	30/25/20×10; Ø10	61×81×34	0,235
TI-200	200/5	0,5	5,0	30/25/20×10; Ø10	61×81×34	0,235
TI-250	250/5	0,5	5,0	30/25/20×10; Ø10	61×81×34	0,235
TI-300	300/5	0,5	5,0	30/25/20×10; Ø10	61×81×34	0,235
TI-400	400/5	0,5	10,0	40/30/ - ×10; Ø30	75×99×40	0,305
TI-600	600/5	0,5	10,0	40/30/ - ×10; Ø30	75×99×40	0,305

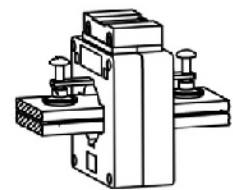

busbar assembly

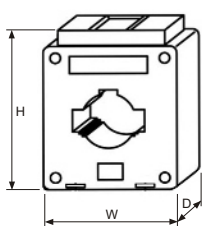

dimensions

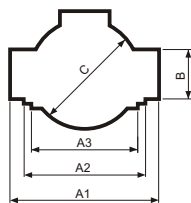

hole P1/P2  
TI-100; TI-150; TI-200; TI-250; TI-300

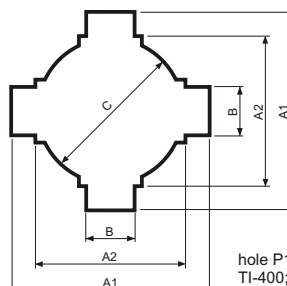

hole P1/P2  
TI-400; TI-600

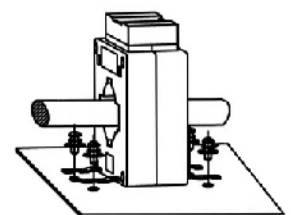

baseplate assembly

# 29.

# VIDEO INTERCOM SETS

## MONITORS

### MK-01



speakerphone  
working with two cameras  
volume control, brightness and color  
plastic + aluminum panel  
color black  
35mm rail adapter included  
wall mount  
dimensions 245 x160 x18



### MK-02



speakerphone  
working with two cameras  
volume control, brightness and color  
plastic + aluminum panel  
color white  
35mm rail adapter included  
wall mount  
dimensions 245 x160 x18

### MK-03



speakerphone  
working with two cameras  
backlit touch keyboard  
LED indication  
volume control, brightness and color  
panel glass  
color black  
35mm rail adapter included  
wall mount  
dimensions 241 x161 x23

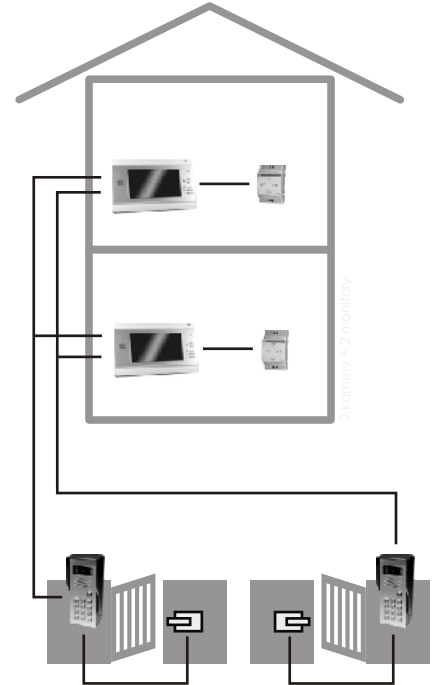

Work configuration:  
1 camera + 1 monitor  
1 camera + 2 monitors  
2 cameras + 1 monitor  
2 cameras + 2 monitors

supply	14,5V DC
power consumption	7W
display	7" TFT LCD
working temperature	-10+55°C
battery	5 modules [85mm]

## GANTRY STATIONS

### KK-01

surface



dimensions:  
58x135x39 [mm]

### KK-03

surface with scrambler



dimensions:  
78x185x60 [mm]

### KK-04

in plaster



dimensions:  
150x203x43 [mm]

### KK-05

in plaster with scrambler



dimensions:  
120x250x43 [mm]

supply	12V DC
power consumption	1,5W
kąt widzenia	70°
open time - program.	1÷99s
transmitter	1/3 CCD
working temperature	-25+55°C
min. illumination	0,05 Lux
backlight	LED
level protection	IP55



**STANDARD OF THE FUTURE IN OUR HOUSE**

F&Home is a dedicated system for the automation of flats, houses and business premises. It provides all the basic functionality of the building automation, such as:

- management and control of heating, cooling and ventilation
- lighting (dimmers, lighting scenes, RGB)
- control of roller shutters, gates and other elements of the motor
- On / off various circuits and receivers (including outlets), external lighting, sprinklers, electrical appliances
- wireless control of Wi-Fi and a remote control and monitoring of GSM
- a complete alarm system with surveillance

Thanks to the "unfolding" of the system into separate subsystems (modules) performing specific functions individually, each can adjust the system to their individual needs and budget.



**GENERAL**

The smart homes system integrate F&Home operating systems regardless of the standard solutions. The integration offers new opportunities and simplifies the control of a vast installation. F&Home is a wired system, lighting, blinds, heating, air conditioning and other equipment powered from any voltage. Communication takes place UTP cables coming down to the main switching station (star system). Because of the distinctive way to control and position wiring system is dedicated to the newly constructed or extensively refurbished buildings. An important feature of the system is free to use equipment. It is permissible to use the buttons, switches and sockets from any manufacturer.,

**CENTRAL UNIT**

The central element of system is a computer with touch panel 12" or 15". Is mounted outside the switchboard in wall using a steel mount casing. powered fro 230V and requires a separate connection to the main switchboard. Communicates with the system through a CAN line. You can self-screen menu, color settings and upload your own favorite images and photos as a screen saver.

Features:

- Introductory Programming (layout of the floor plan)
- Programmable dimmer settings (hysteresis)
- Set the device programmer (on an annual basis every 15 minutes)
- Setting up programmer for heating and cooling
- Setting the hysteresis motor devices (blinds, shutters)
- Defining the scenes (may include a light, blinds, temperature, switching on some receivers)
- Set the color of the interface (fit to your needs)
- Uploading images to the screen (electronic box)
- Setting up the GSM and Ethernet
- Update software (via USB stick)



komputer z panelem w obudowie montażowej

Taking care of the aesthetics of the interior of the customer can choose a steel frame with masking patterns among the 12 available colors. Easy to install frame and color palette of colors is a guarantee of fit into any decor.

steel frame



as digit frame

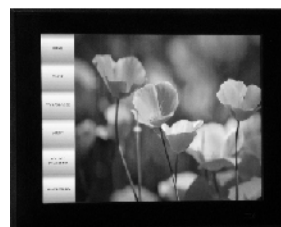

**AUXILIARY PANEL**

Touch 5.7 inch unit is designed for mounting on floor or in the living room to control the advanced features of the system without going to the main panel. Scenes can contain settings for the lighting in the room, lowering or raising blinds, set a specific temperature and the activation or exclusion of specific receivers. For the scene buttons can be assigned to previously uploaded images through the main panel. Number of scenes is basically unlimited and depends on user needs. For the complete steel frame should be selected from among 12 camouflage color patterns available in line with the central panel frames.



**GRAPHICAL INTERFACE - USER MENU**

The clear and intuitive menu structure allows for central control of entire devices in the system. Attractive visualization are an additional decorative element. Additionally, you can self-screen menu, color settings and upload your own favorite images and photos as a screen saver.

Visualization of a house or apartment rooms - based on plans supplied by the customer - is done free of charge by our programmers.

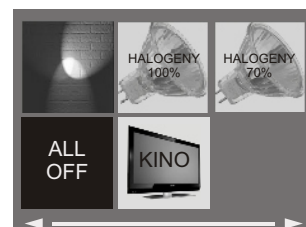

panel pomocniczy 5,7"

**REMOTE CONTROL GSM i WI-FI**

Optionally, the system F&Home has the ability to connect wirelessly to a home Wi-Fi router and through our special website, you can remotely monitor the system from any computer in the world. GSM features to easily allow you to remotely control the system via SMS text messages. By sending a special SMS message can include / exclude any receiver in the building, check that the specified circuit is on, read the temperature of the room, or run a specific stage (eg raise the temperature, open the gate, illuminate the driveway, etc.).



The function of an extended pilot house meets Tablet 7 "Samsung Galaxy TAB P1010 with the application F&Home Phones to control the system via WiFi. Application allows you to control the defined scenes and make changes to the settings of these scenes.

**SWITCHBOARD, HARDWARE AND CABLES**

The system operates in a star, it means that all control cables and power of individual receivers converge at a switchboard. Due to the large number of cables should be used with large switching (96 modules or more) or free-standing cabinet. It is also permissible to use two switching, for example on the ground floor and first floor. In this case, section switchboards should be placed between the CAN bus line. The position requires a large amount of wiring, so installation should be performed before applying the plaster. During installation, together with tynkarzami (fill switching computers and enclosures) and plumbers (control solenoid). The focal point of the system is switching and going off all the wires (star system). For switchboard to bring the signal from the UTP cable controls such devices as on-off (lights, sockets and other). For the control system can use any type of accessories (buttons, switches, sockets) available on the market.

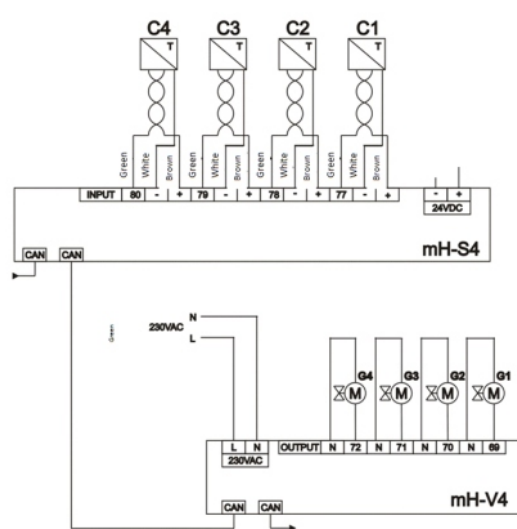
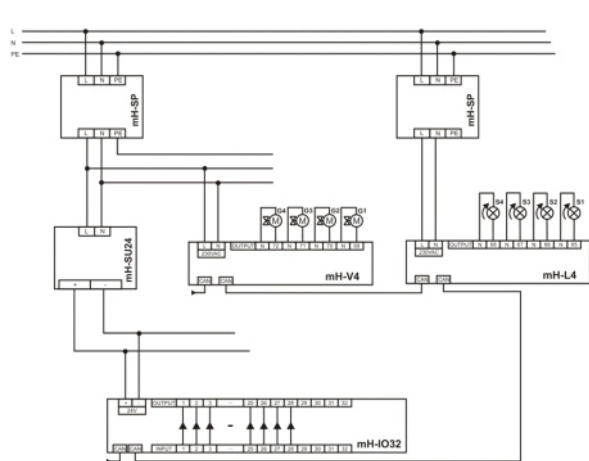

**INSTALLATION COST and SAVINGS**

The cost of building an intelligent system is certainly a higher initial expense. But the economic effect is not determined by only one-time cost incurred in the investment, but also the subsequent maintenance and operation costs. By installing F&home must be aware that an investment in the future. With time, save on costs associated with heating and lighting and operation of facilities TV. High initial cost to purchase the system components. The cost of building a wired installation F & Home marginally above the cost of a standard cable (about 1000zł more with 150m<sup>2</sup> floor space). Installers, electricians work is comparable with the location of a computer system or alarm. The whole system is the cost, and so 3-4-fold lower than that of other known systems of this type.

Integration with central heating with system, F&Home allows you to reduce heating costs by up to 40%. This effect is achieved thanks to the possibility of valve control circuit for central heating and individual temperature control program, depending on time of day, and the presence and activity of the household. There has also been savings - up to 15% - achieved by controlling the light as a function of time and place, such as the setting of illumination depending on time of day. Additional savings can be achieved with proper control of the other receivers, such as electronics devices, when leaving the house when using the feature disable Disable All these receivers from standby

Approximate cost of the system components (according to the rates in September 2010):  
 apartment of about 70m<sup>2</sup> - price around 9.000zł\*  
 house / apartment approximately 120m<sup>2</sup> - price around 12.000zł\*  
 house 150-200m<sup>2</sup> - price around 15.000zł\*

**SYSTEM INSTALLATION**

Installation of F&Home can make a qualified installer, who received training in the field of installation, operation and configuration. In the case of self-assembly or by an unauthorized installer company F&F can refuse free technical support and to express terms of warranty on parts and installation of the system. Authorized installer's business is personalized card with your name and authorization number.





**COMPONENTS**

- mH-IO32* input-output module control 28 devices on - off..
- mH-IO12E6* mixed module IO12E6 control 12 devices on - off and six motor equipment.
- mH-E16* engine control module 16 motor units of type blinds, awnings, doors, roof windows with the drive.
- mH-L4* executive Module Four dimmers (4x350W)
- mH-S4* four-channel sensor module (sensors included).
- mH-S8* eight-channel sensor module (sensors included).
- mH-V4* four-valve module executive (executive element - semiconductor).
- mH-V8* eight-module executive (executive element - semiconductor).
- mH-V7+* executive seven-valve module and pump control CO or furnace..
- mH-R2x16* relay module (2 pcs 16A)
- mH-R8x8* Relay Module (8 pcs 8A)
- mH-SP* module with surge protectors surge module.
- mH-SU24* power supply 30W
- mH-SU50* power supply 50W
- mH-Kh* Cables - house
- mH-Kf* Cables - apartment
- mH-ETH* Ethernet module (connection of internet by WIFI)
- mH-Mrg* GSM module
- mH-Mb* Master module(built-in computer)
- mH-TS12* Computer 12" with touch panel
- mH-TS12s* Ramka stalowa komputera 12"
- mH-TS15* Computer 15" with touch panel
- mH-TS15s* Steel frame of computer 15"
- mH-TS5* Touch monitor 5,7" for scene functions
- mH-RGB* control module LED RGB
- mH-MS* module scenes (16 inputs). It allows you to trigger scenes using buttons..
- mH-MK* light module (16 channels). It allows the visualization of states on the screen on / off, open / closed (max 16).
- mH-RP* Tablet 7 "Samsung Galaxy TAB P1010 with the application F & Home Phones to control the system F & Home with WiFi.

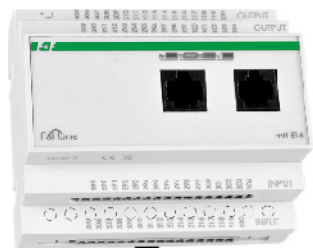
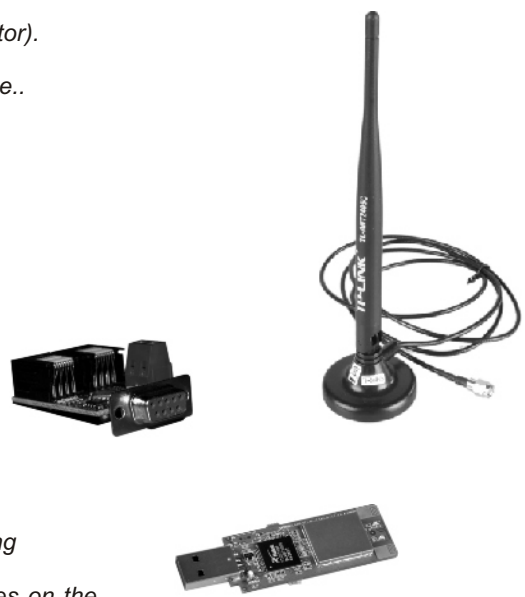

# 31. PROGRAMMABLE LOGIC CONTROLLER PLC

www.plcmax.pl



## PURPOSE

PLC MAX controllers are designed to solve a wide range of tasks of management and technological processes and data exchange. It is used in home and industrial automation on low and medium level of technological advancement. Group of controllers with GSM communicator is designed for management of technological processes and data exchange via the mobile network GSM 900/1800 in SMS, GPRS mode and voice call (using a DTMF and CLIP).



## H series

### PURPOSE

Are used in home automation and industrial low and medium level of technological advancement. Made in a compact case designed for mounting directly on a flat surface (wall, table) as well as switchboards (35mm rail).



H01

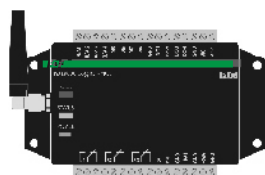

H02



H03

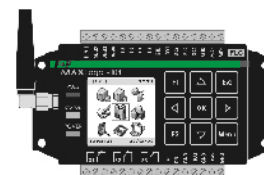

H04

**H01** Basic version

**H02** With GSM communicator

**H03** with front panel (LCD screen + keyboard)

**H04** With GSM communicator, front panel (LCD screen + keyboard), GUI

program system cycle	10msec
supply	9+30V DC
digital inputs	4 (30V; 0,2A)
analog/digital inputs	4 (0/4+20mA/0+10V)
digital outputs	4 (50V; 0,2A)
relay outputs N/C	3x[<5A]
ports	SD, microUSB, SIM, RS485
communication port	MODBUS RTU
register internal memory	1,3MB
working temperature	-10+50°C
power consumption	1W
connection	screw terminals 1,5mm <sup>2</sup>
dimensions	110x79x40mm
fixing	to the base or on the rail TH-35

MAX Logic H04 is one of the few drivers to enable connection and use it without the elements of programming. Using menu configurator, anyone can utilize who does not want to know the language and the complicated procedures of PLC programming.

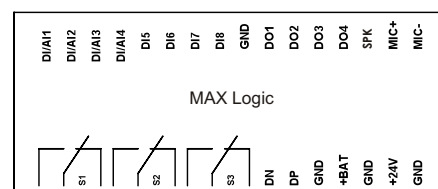
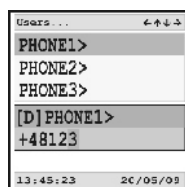
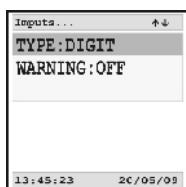

series S



S01



S02



S03



S04



antenna GSM

type	S01	S02	S03	S04
program system cycle	10msec	1msec	1msec	1msec
supply	9+30V DC			
digital input/output DIO (30V; 0,2A)	6	6	6	6
fast counting inputs 100kHz	-	1	-	1
output PWM	-	1	-	1
analog inputs 0/4+20mA / 10 bits	-	2	2	2
port SD	-	■	-	■
port microUSB	■	-	■	-
port SIM	-	-	■	■
port RS485 + MODBUS RTU	-	■	-	■
work mode MODBUS	-	MASTER	-	MASTER
module GSM	-	-	■	■
funktions GSM	-	-	SMS/CLIP	SMS/GPRS/CLIP
register	-	■	-	■
internal memory	-	2MB	-	2MB
clock RTC	-	■	-	■
event sound indication	-	■	■	■
working temperature	-20+50°C			
power consumption	0,5W	0,8W	8W	8W
connections	screw terminals 1,5mm <sup>2</sup>			
dimensions	1 mod.(18mm)	3mod.(52mm)	3mod.(52mm)	3mod.(52mm)
fixing	on the rail TH-35			

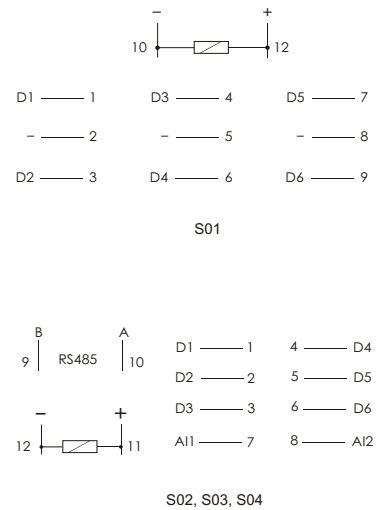

SOFTWARE TOOLS

For carrying out and interpreting program in **ForthLogic** responsible programming and hardware system called the forth-system. Computational model underlying the language ForthLogic consists of stacks, global variables, the dictionary, the input and output buffer. ForthLogic language allows to describe the processes running in parallel and operates in a multitasking environment.

Interactive programming environment and creating applications for controllers MAX in ForthLogic consists of a text editor **Notepad++**, terminal program **PuTTY** and the program **ForthLogic Programmer** providing two-way communication between PC and controller MAX. Your environment, you can create scripts ForthLogic, program MAX controllers and communicate with the controller in terminal mode.

**MAXLadderSOFT** program provides an easy way to convert schema "relay" at programming language of controller. The program allows creating and editing applications using ladder diagram language [LAD], checking the correctness of the construction schedule, the directly communication controller with a computer, upload the application to the PLC.

Direct work with the system controller called a **box mode**. There are two types of work box: terminal and remote. **Terminal Mode** is working with a program like **HIPERTERMINAL** (MAX-PC connection USB cable). Terminal Mode primarily use for learning programming, solving programming tasks or solving existing problems in the operation of the controller. **Remote mode** - only for controllers with GSM module - this controller work with the phone via SMS. In this mode the phone screen fulfills a similar function as a terminal window on your computer monitor. Remote mode is clearly to use remote control devices connected to the controller.

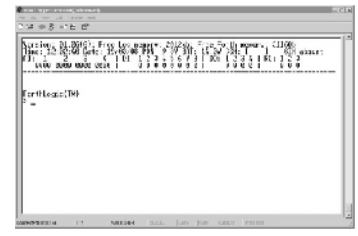

HyperTerminal

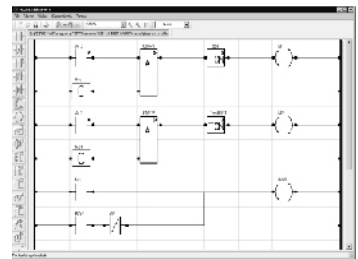

MAX-LadderSOFT

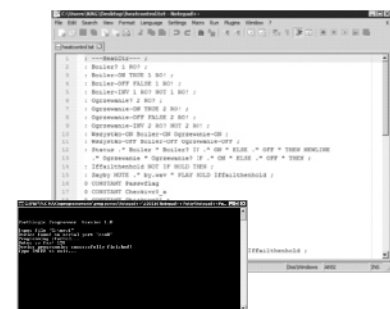

Notepad++PuTTY ForthLogic Programmer

# AN IDEOLOGICAL DIAGRAM OF COMMUNICATION BETWEEN PLCMAX controllers with external measurement devices and expansion modules

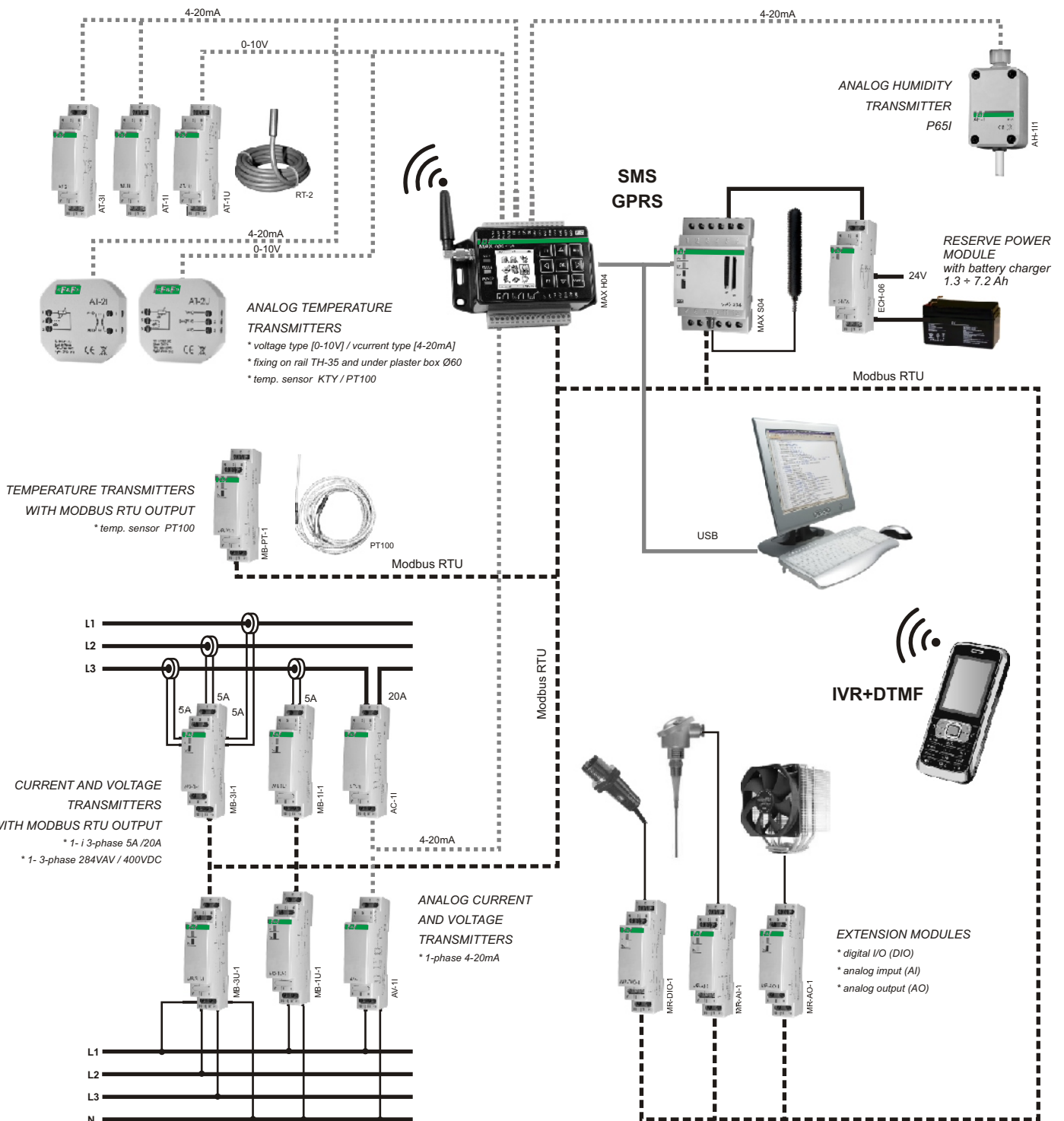

**SIGNAL TRANSMITTERS (chapter 27):**

- analog transmitters
- transmitters with MODBUS RTU output
- extension modules

**CURRENT TRANSFORMER (chapter 28)**

**RESERVE POWER MODULE DC (chapter 26)**

**TEMPERATURE PROBE (chapter 25)**

# NETWORK PARAMETERS REGISTRATION SYSTEM



## LogDMM LogDMM-D

### PURPOSE

The system is dedicated to registration of 3-phase network.

### PARTS OF THE SYSTEM:

**LogDMM:** controller MAX H01, multimeter DMM-3T, gel battery ACCU-Hp1,3Ah-12V, termination modulese LT-04 (2 pcs.), memory card SD 2GB], soft + manuals.  
**LogDMM-D:** controller MAX H01, multimeter DMM-3T, gel battery ACCU-Hp1,3Ah-12V, termination modulese LT-04 (2 pcs.), memory card SD 2GB], soft + manuals.  
 Power suplier G1 24V available separately (np. ZI-24).

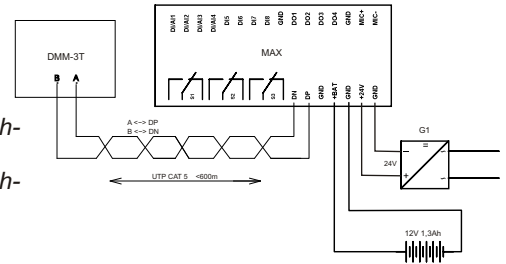

Circuit devices DMM-3T and MAX used for reading and recording parameters of three-phase system. Controller and multimeter to communicate through the port RS485 using the communication protocol MOTBUS RTU. The controller periodically records retrieved network parameters and stores them in internal memory. Writing in the internal memory is periodically transferred to a text file on the SD card.

Recorded parameters:

- Date [YYYY-MM-DD]
- time [hh: mm: ss]
- three phase voltages (U1, U2, U3)
- three phase currents (I1, I2, I3)
- network frequency (F)
- power factor (cosφ)
- active Power (P)
- reactive Power (Q)
- apparent power (S)
- positiv activ energy (+Wh) [kWh]
- negativ activ energy (-Wh) [kWh]
- positiv reactive energy (+varh) [kvarh]
- negativ activ energy (-varh) [kvarh]

Simultaneously are recorded parameters of the correctness of read registers (status):

0 - read the correct; 16 - lack of response, such as off multimeter, broken communication cable, etc.; 17 - wrong checksum in the response (an incorrect result), for example, an error resulting from the disturbance of the communication cable.

Start reading registers is indicated by a single low beep. Backup registry is stored on an SD card to a file LogDMM.txt. In the absence of an SD card in the port driver backup will not be made, but all registration data will be stored in internal memory. If the SD card is loaded at the port, then the next time backup'ie all data from the internal memory are saved to a file on an SD card. Finished reading and writing registers in the multimeter's internal memory is indicated by a single high beep. Single beeps at intervals 0.2sec means the process of transferring data from internal memory to SD card. Correct save[backup] to file on an SD card is indicated by four sounds modulated signal. Minimum registers cycle reading time is 1.0 sec.

**LogDMM:** all settings of cycle times, dates, time, and backup perform is done by using special commands uploaded to the controller via SD card

**LogDMM-D:** all settings of cycle times, dates, time, and backup is done by using main menu on controller's LCD screen. Additionally using front panel and buttons we may start and stop registration process also get the message about controller - multimeter communication.

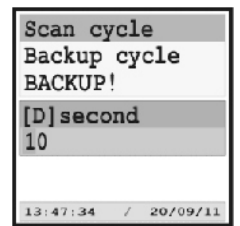

LogDMM-D's program menu

Look of registered data imported into Excel spreadsheet.

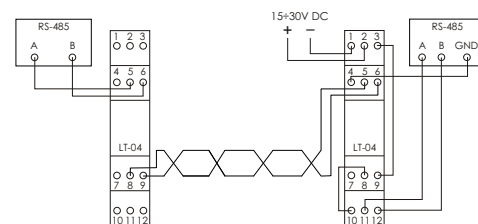

Optional connection of termination modules in order to RS-485 network polarization.

# 32.

# ENCLOSURE DIMENSIONS

[mm]

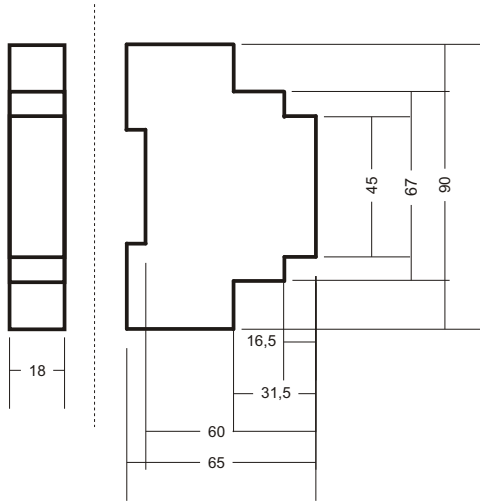

1 modul

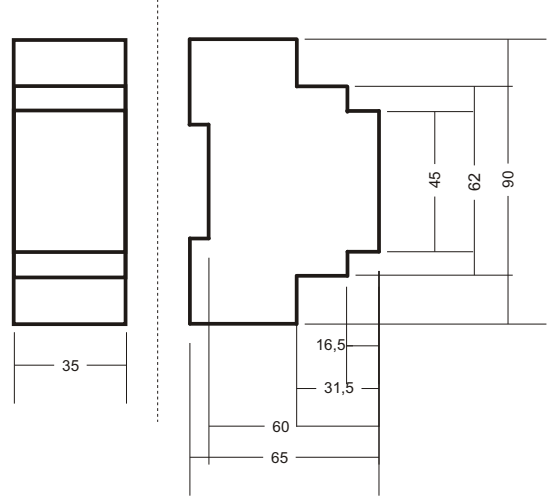

2 modules

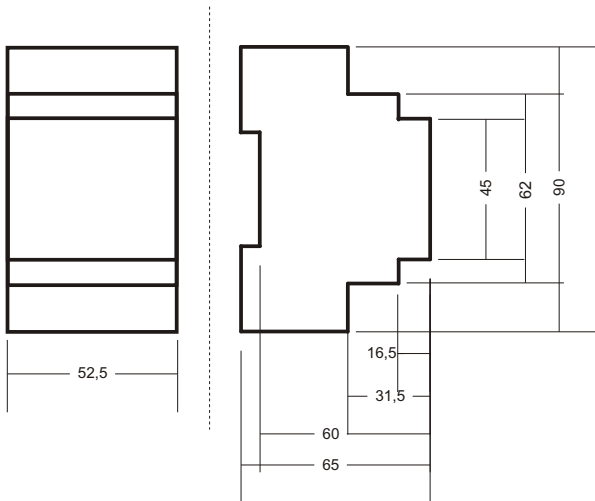

3 modules

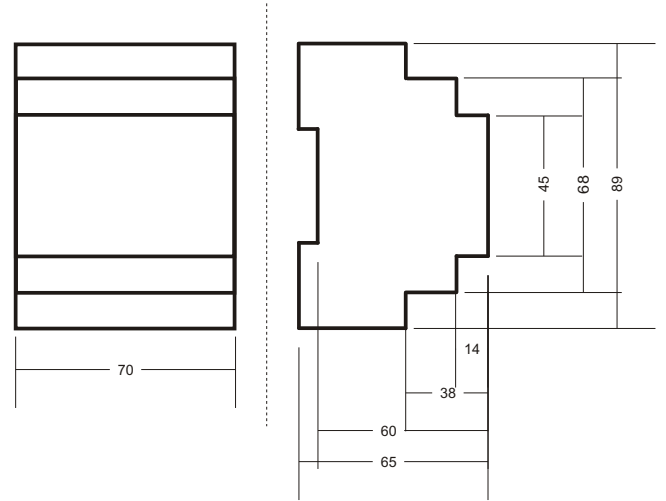

4 modules

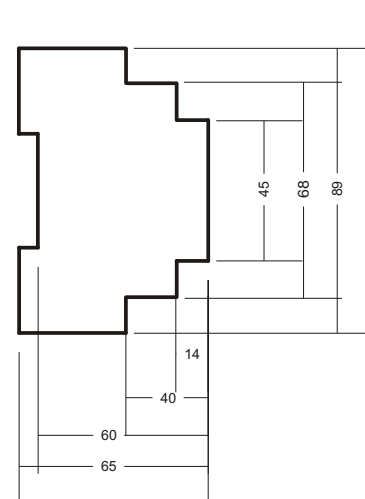
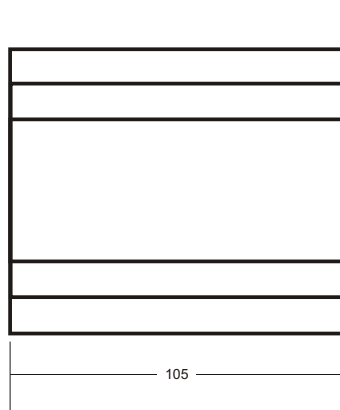

6 modules

[mm]

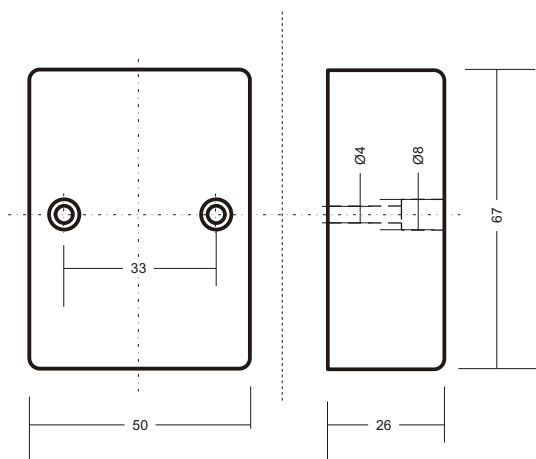

*to plater box*

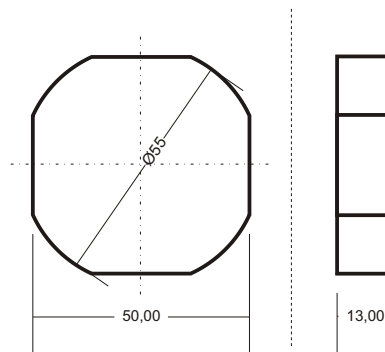

*to under plaster box*

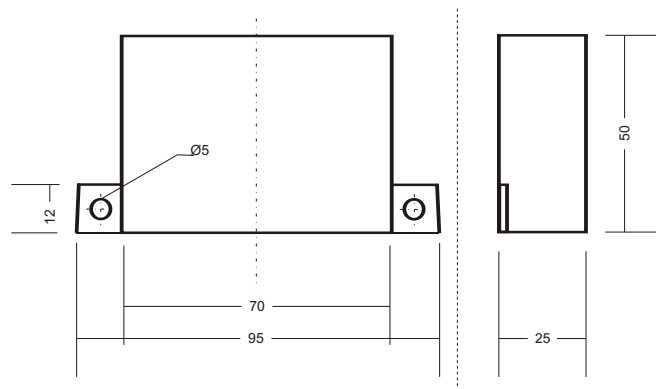

**CZF2 PO-405**

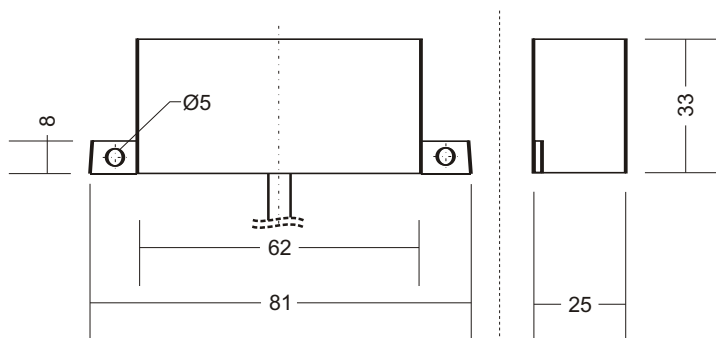

**AZH-C**

**NOTATKI**

A large grid of graph paper for taking notes, consisting of 20 columns and 30 rows of small squares.